

# ARRI<sup>®</sup>

---

## WCU - 3

### Instruction Manual

As of: February 2012

ALL ARTWORK, PICTURES AND TEXTS ARE COVERED BY OUR COPYRIGHT.

THEY MUST NOT BE COPIED FOR REPRODUCTION (E.G. ON CD-ROM DISKS OR INTERNET-SITES) OR USED IN THEIR ENTIRE FORM OR IN EXCERPTS WITHOUT OUR PREVIOUS WRITTEN AGREEMENT.

IF YOU ARE DOWNLOADING PDF-FILES FROM OUR INTERNET HOME-PAGE FOR YOUR PERSONAL USE, MAKE SURE TO CHECK FOR UPDATED VERSIONS.

WE CANNOT TAKE ANY LIABILITY WHATSOEVER FOR DOWNLOADED FILES, AS TECHNICAL DATA ARE SUBJECT TO CHANGE WITHOUT NOTICE.

This page is left intentionally blank

# 1. Contents

<b>1. Contents</b> .....	3	<b>6. Battery Maintenance</b> .....	26
<b>2. Safety Instructions and Legal Disclaimer</b> .....	4	<b>7. Specifications</b> .....	27
2.1 Safety instructions .....	4	<b>8. ARRI Service</b> .....	29
2.2 Disclaimer .....	6		
<b>3. General Description</b> .....	8		
3.1 ARRI Order Numbers .....	10		
3.2 Control Scope .....	11		
3.3 Common Operating Procedures .....	12		
3.4 Status Screen Elements .....	13		
<b>4. Operation</b> .....	14		
4.1 Screen Menus .....	14		
<b>5. Setup</b> .....	18		
5.1 Wireless Setup .....	18		
5.2 Selecting the radio channel ("Yellow Radio") .....	18		
5.3 Selecting the radio channel ("White Radio") .....	19		
5.4 Optional Zoom Control .....	20		
5.5 Wired Setup .....	22		
5.6 Knob Friction Adjustment .....	25		

## 2. Safety Instructions and Legal Disclaimer

### 2.1. Safety instructions

The WCU-3 has been thoroughly tested for quality of workmanship and operating functions before leaving the factory.

To ensure optimal performance, it is essential that you acquaint yourself with this instruction manual and that you follow the operating instructions described.

#### Warning signs



Possible risk of injury or damage to equipment.



This symbol indicates the risk of electric shock or fire danger that could result in injury or equipment damage.

### General safety instructions



Read and understand all safety and operating instructions before you operate or install the system.



Retain all safety and operating instructions for future reference.



Heed all warnings on the system and in the safety and operating instructions before you operate or install the system. Follow all installation and operating instructions.



Do not use accessories or attachments not recommended by ARRI, as they may cause hazards and void the warranty.



Do not repair any part of the system. Repairs must only be carried out by authorized ARRI repair shops.



Do not remove any safety measure of the system.



Do not operate the system in high humidity areas or expose it to water or moisture.



Do not place the system on an unstable cart, stand, tripod, bracket, or table. The system may fall, causing serious personal injury and damage to the system or other objects.



Operate the system using only the type of battery and charger indicated in the manual.



Do not use solvents to clean.

Any violation of these safety instructions or the non-observance of personal care could cause serious injuries (including death) and damages on the system or other objects.

**Note:** *Notes are used to indicate further informations or informations from other instruction manuals.*

### **Product Identification**

When ordering parts or accessories, or if any questions should arise, please advise your type of product and serial number.

## 2.2 Disclaimer

Before using the products described in this manual be sure to read and understand all respective instructions. The ARRI Wireless Lens Control System is only available for commercial customers. The customer grants by utilization, that the ARRI Wireless Control Unit (WCU-3) or other components of the system are only deployed for commercial use. Otherwise the customer has the obligation to contact ARRI preceding the utilization.

While ARRI endeavors to enhance the quality, reliability and safety of their products, customers agree and acknowledge that the possibility of defects thereof cannot be eliminated entirely. To minimize risks of damage to property or injury (including death) to persons arising from defects in the products, customers must incorporate sufficient safety measures in their work with the system and have to heed the statuted canonic use.

No part of this document may be copied or reproduced in any form or by any means without prior written consent of ARRI. ARRI assumes no responsibility for any errors that may appear in this document. The information is subject to change without notice.

For actual design-in, refer to the latest publications of ARRI data sheets or data books, etc., for the most up-to-date specifications. Not all products and/or types are available in every country. Please check with an ARRI sales representative for availability and additional information.

ARRI or its subsidiaries does not assume any liability for infringement of

patents, copyrights or other intellectual property rights of third parties by or arising from the use of ARRI products or any other liability arising from the use of such products. No license, express, implied or otherwise, is granted under any patents, copyrights or other intellectual property rights of ARRI or others.

ARRI or its subsidiaries expressly excludes any liability, warranty, demand or other obligation for any claim, representation, or cause, or action, or whatsoever, express or implied, whether in contract or tort, including negligence, or incorporated in terms and conditions, whether by statute, law or otherwise. In no event shall ARRI or its subsidiaries be liable for or you have a remedy for recovery of any special, direct, indirect, incidental, or consequential damages, including but not limited to lost profits, lost savings, lost revenues or economic loss of any kind or for any claim by third party, downtime, good-will, damage to or replacement of equipment or property, any costs or recovering of any material or goods associated with the assembly or use of our products, or any other damages or injury of persons and so on or under any other legal theory.

In the case one or all of the forgoing clauses are not allowed by applicable law, the fullest extent permissible clauses by applicable law are validated.

ARRI is a registered trademark of Arnold & Richter Cine Technik GmbH & Co Betriebs KG.

This page is left intentionally blank

## 3. General Description

The Wireless Control Unit WCU-3 combines robust 2-axis lens control with radio control capability in combination with any member of the 3<sup>rd</sup> generation (“Yellow Radio”) or 4<sup>th</sup> generation (“White Radio”) ARRI Wireless Remote System.

Bidirectional data transmission allows the display of actual camera status and ARRI LDS lens data, if available.

### Main features

- Light-weight handheld unit
- Integrated Iris and Focus controls
- Clearly arranged controls and menus
- Easy readable display under all lighting conditions
- Illuminated controls
- Weatherproof design
- Left-handed operation at “the press of a button”
- Powered from integrated, removable battery or external power supply
- Fully integrated in the ARRI Wireless Remote System
- Optional hard-wired operation via ARRI LCS-bus
- Optional 3-axis lens control with ARRI ZMU-3 Zoom Control on bracket
- Mixed wired and wireless control
- ALEXA Plus/Studio Lens Control compatible



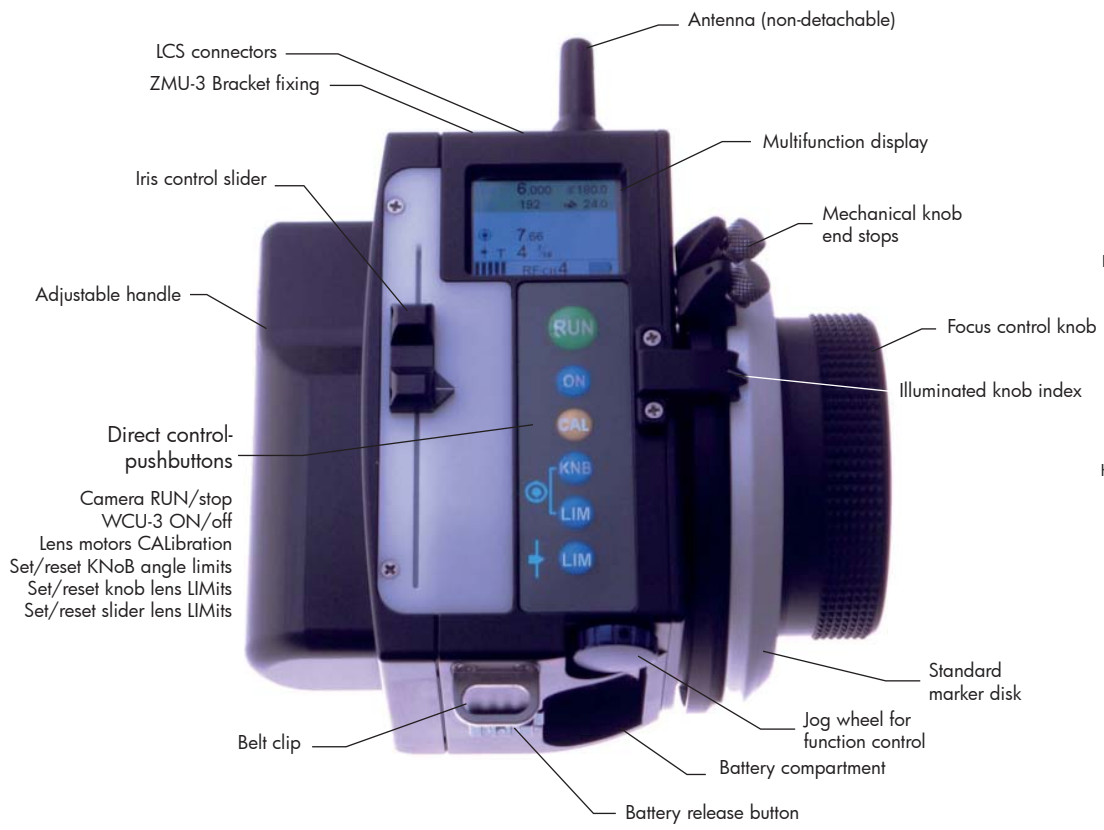

K2.65132.0 ZMU-3 Bracket assy.



K2.65162.0 marker disk Z-type



K2.47851.0 Li-Ion Battery



K2.47852.0 Battery Charger

### 3.1 ARRI Order Numbers

**K2.65155.0      Wireless Control Unit WCU-3 complete, built-in „Yellow“ Radio**

consists of

	WCU-3 Wireless Control Unit
K5.67999.0	WCU-3 User Manual
K2.47248.0	Marker disk - standard
05.21150.0	Belt

Charger power cords:

05.20369.0	Power Cord UK
05.20370.0	Power Cord US
05.20368.0	Power Cord EU

**K2.65155.W      Wireless Control Unit WCU-3 complete, built-in „White“ Radio**

consists of

	WCU-3 Wireless Control Unit
K5.67999.0	WCU-3 User Manual
K2.47248.0	Marker disk - standard
05.21150.0	Belt

**Cables:**

K4.41395.0	K-LC-Z1-S LCS cable 3,5m (11ft)
K4.41397.0	K-LC-M1-Sp-S LCS spiral cable
K2.65159.0	KC 129-S WCU-3 to ZMU-3 cable 0,25m (0.8ft)
K2.65009.0	KC 92-S LCS to ZMU-3 cable 0,8m (2.5ft)
K2.65010.0	KC 93-S LCS to ZMU-3 cable 10m (33ft)
K2.41389.0	LC-E1 LCS Cable Drum Extension 75m (250ft)

**Recommended battery and charger**

K2.47851.0	SONY NP-FM 500H Li-Ion Battery 7,2V 11.8Wh
K2.47852.0	SONY BC-VM50 Li-Ion Battery Charger with Power Cord EU
K2.65236.0	Battery and charger set 2x Battery, 1x Charger w.Europe + US plug

**Accessories:**

K2.65132.0	ZMU-3 Bracket assy. for WCU-3
K2.65162.0	Marker disk - Z- type
K2.65176.0	Wooden Handgrip Assy.

## 3.2 Control scope

### Wireless

Compatible partner units Radio Type vs. min. SW Version  
„Yellow“ „White“

<b>WCU-3</b>	<b>Packet</b>	<b>02A</b>	<b>02A</b>
ALEXA Plus/Studio	SUP	3.1	3.1
ARRIFLEX 435 Adv w. FEM-2	Packet	03D	04A
ARRIFLEX 435 Xtreme	Packet	03D	04A
ARRIFLEX 416 Plus (HS)	Packet	03B	04A
ARRICAM w. LDB-ST/LT	Packet	04D	05A
D21 with FEM-2	Packet	1.17	*
UMC-3(A)	Packet	02F	04A
UMC-1 w. URM-2/-3	Firmware	1.60	--

\* D21 (SW-Packet 1.17) with FEM-2 Packet 3.00

The ZMU-3(A) extends the WCU-3's control capabilities to an additional zoom control, being powered from the WCU-3's battery.

#### Note:

*Radio communication is only possible between equally color coded radio units:  
"Yellow Radio" to "Yellow Radio",  
"White Radio" to "White Radio"*

### Hardwired

Using the ARRI LCS-Bus wiring, the WCU-3 accepts the Cameras/Lens Motor Control Units (UMC-X) mentioned in the „Wireless Section“ as well as the units listed below for control and/or communication.

### Mixed wireless and wired control

Wireless control of axis not LCS-wired is also possible

### WCU-3 accessory units

ZMU-3 (A)	Firmware	02C
ZMU-1/-2	Firmware	2.09
CLM-1	Firmware	2.18
UMC-1	Firmware	1.60

To tap the full potential of the WCU-3's possibilities, be sure to having updated all connected units to a software version equal or higher to those listed.

*For setup details please refer to chapter 5.*

### 3.3 Common Operating Procedures

The pushbuttons on the front allow access to the main functions.

- ON Press briefly to switch-on the WCU-3. To switch-off the WCU-3 press and hold ON for more than 2 seconds.
- RUN Starts/stops the connected camera (toggle function)
- CAL *CAL request on the display:* Press CAL button briefly for lens motor calibration  
*Intentional Calibration:* Press and hold CAL for more than 2 seconds to run a calibration cycle

CLM-3 Lens Motor Operation:



Due to its very high torque, the CLM-3 motor needs special attention in usage.



**Careless calibration or mounting may ruin lens mechanics!**

To minimize the risk of lens damages, any ARRI CLM-3 capable lens control system with a CLM-3 connected, sends a CAL request every time a CLM-3 drive unit has been repowered. ONLY in case you are REALLY SURE that the CLM-3 motor setup has not been changed, you may override this CLM-3 dependent CAL request by double-pressing the CAL button within 0.5 seconds.

- KNB  Turn the focus knob to the desired START focus value. Press and hold the KNB button and turn the focus knob to the chosen STOP focus value\*. Release the KNB button.

- LIM  Turn the focus knob to the desired START focus value. Press and hold the LIM button and turn the focus knob to the chosen STOP focus value\*. Release the LIM button.
- LIM  Shift the iris slider to the desired START iris value. Press and hold the LIM button and shift the iris slider to the chosen STOP iris value\*. Release the LIM button.

\*During change-over to the STOP position the appropriate **KNB** or **LIM** symbol appears in the display, toggling in size. After successfully setting the limits, the larger symbol appears steadily in the display.

Reset from limitation by briefly pressing the appropriate button.

*Note:* This description assumes that the iris is assigned to the slider and the focus is assigned to the knob.

The jog wheel, located on the lower end of the push-button line, allows access to the WCU-3's menu system.

Press the jog wheel button to enter the menu system from the initial (status) screen or to select the highlighted menu item.

Turn the jog wheel to make a - highlighted - choice from the displayed menu items.

To exit from any menu, highlight the EXIT  symbol in the lower right screen corner and press the jogwheel button.

### 3.4 Status Screen Elements

**Camera Status**

Color  
WHITE  
GREEN  
RED

Film Camera  
STANDBY  
RUN  
ASY

STANDBY: Preset camera speed  
RUN: Actual camera speed

Exposed film length / remaining recording time  
Unit depends on magazine setting

Message line

Lens Motor Status  
Lens Data  
information, if available  
Unit depends on LDS lens  
or Lens Data Archive settings

Knob

Slider

Actual camera shutter angle

Camera power supply voltage

Operational information  
Video Camera: Exposure Index and White Balance setting

Lens Motor Limits information

EXIT symbol

RF signal strength

Radio channel

Battery charge status

WCU-3 Status

Different WCU-3 Status symbols will be shown in hardwired configuration, for a detailed description refer to chapter 5.5

**ALEXA Screen example**

Free Storage Space

Exposure Index

Camera Status  
red : Record  
green : Standby

Basic White Balance setting information, CC not shown

**Note:**

The displayed data depends on the connected camera or motor control unit:  
e.g. an ARRIFLEX 416 cannot transmit its shutter angle in standby, an UMC-1/URM-2 cannot send camera data, etc.

## 4. Operation

Slide in the battery into its compartment. Switch on the WCU-3 using the blue ON button.

The Status Screen appears and the WCU-3 tries to connect to a matching partner unit. If ok, CALibrate the lens motor(s) and the WCU-3 is ready for operation. Some user-definable functions can be adjusted through a simple menu system.

### 4.1 Screen Menus (WCU-3 SW packet 02A)

Enter the WCU-3 Main Menu by briefly pressing the jog wheel button. The Main Menu Screen appears.



Highlight one of the provided menu items by turning the jog wheel, push briefly the jog wheel button to enter the next menu level or select the EXIT symbol and press to return to the Status Screen.

### Backlight Menu

The display illumination can be adjusted to 3 brightness levels or may be switched off completely. Select the desired brightness level, press, then highlight the EXIT symbol and press to return to the Status Screen.



### Channel Menu

Select the radio channel or switch off the radio by turning the jog wheel. Press to return to the Status Screen.



"Yellow Radio" screen



"White Radio" screen

For a detailed description of the ARRI wireless system setup refer to chapter 5.ff

## Options Menu

The Options Screen holds special user dependent functions as well as the Software Version information.

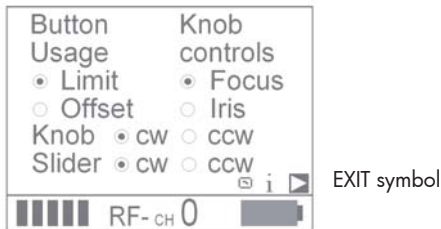



**Button Usage** programs the LIM buttons to either setting Limits or adding Lens Scale Offset used in UMC-3(A) 3D applications or correction of Lens Data Archive scales.

Knob controls either the Focus or Iris lens motor. The respective other axis will be directed to the Slider. Knob and Slider may be set to clockwise or counter-clockwise direction operation.

Note: To allow the use of separate WCU-3's for Focus and Iris control, control should be set up like this:

- WCU-3 #1: Knob controls Focus -> controls Focus Lens Motor
- WCU-3 #2: Knob controls Iris -> controls Iris Lens Motor

Highlight the chosen item and confirm your selection by briefly pressing the jog wheel button. Highlight the , **i** or  symbol and press to select the sub-screens or return to the Status Screen.

The Display Alignment allows the display view to be turned upside down for easier use for left-handed people. For even more convenient handling of the WCU-3 also turn the side handle by 180°. Use a 3mm hex wrench for the handle adjustment.

**Note:** Due to the upside down orientated antenna, the transmission range may be reduced.

 screen

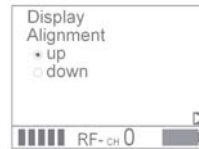

WCU-3 Software and Hardware Version information

**i** screen



## Motor Torque Limit Menu

In this screen the CLM-3 motor torque can be adjusted in four steps. The adjustment is only available if a motor with high power drive is detected (UMC-3A, ARRIFLEX 416 PLUS (HS) or ALEXA Plus/Studio)  
high value (4) - high torque - low value(1) - low torque

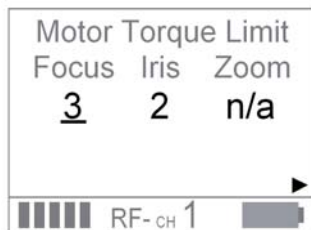

**Note:** Controlling the ALEXA Plus/Studio, torque adjustment is possible at the ALEXA Plus/Studio only.

## Torque Adjustment Instructions

Please select the required torque level carefully:

Higher torque levels should be used for rough-running lenses.

**Note:** Take care to re-calibrate the CLM-3 motor after re-attachment of the motor and after each lens change!  
Ignoring this procedure can lead to severe lens damage.

Lower torque levels should be used for smooth-running lenses.

**Note:** If the torque level is not adequate to lens properties or operation temperature, the electronic torque limitation may cause a high-frequency noise.  
Use a higher torque level to reduce this effect.



## Lens Menu

Currently no function, reserved for future applications.

## Message Descriptions

Searching for host	WCU-3 searches for wireless partner unit
Connection lost	wireless partner unit switched-off, distance too high or interference with other wireless units
Go to second limit	limitation settings: Turn knob or shift slider to the second limit position
No motor control	no lens motor connected, another WCU-3 already drives the selected lens motor
Battery empty	shut-off the WCU-3 and replace/recharge the battery immediately
Please calibrate	lens motors need calibration

## 5. Setup

Every time, the control setup has been established or changed, a power cycle and calibration is advisable.

### 5.1 Wireless setup

#### Radio Channel Setup

The two available Radio types “White” Radio and “Yellow” Radio are NOT compatible to each other! Therefore ARRI Radio equipped units can generally only control/communicate to units with the same Radio type.

To establish a connection of one or more Wireless Hand Control Units\* (a maximum of three per radio channel is possible), the WCU-3 must be set to the same radio channel as the camera or the Motor Control Unit.

*Please refer to Section 3.2 for unit's compatibility.*

It is not possible to control more than one motor control unit with one WCU-3.

Select the radio channel by pushing the jog wheel at the unit's lower side and select the Channel Menu.

*Please refer to Section 4.1 for details.*

### 5.2 Selecting the radio channel (“Yellow Radio“)

The “Yellow” radio modem in the WCU-3 utilizes a specific scheme of constantly changing frequencies, making the connection between the different radio units very robust against interference. The even channels on the radio channel selector switch (numbers 0, 2, 4, 6) utilize the upper half of the bandwidth (2444 - 2472 MHz) while the odd numbers (1, 3, 5, 7) use the lower frequencies (2406 - 2435 MHz).

In case two remote systems with yellow antenna washer must work side by side on different channels, it is recommended to set one of the systems to an upper (even) channel and the other system to a lower (odd) channel number.

Due to local telecommunications regulations, only certain channels are allowed in some countries.

The WCU-3 must be used with odd channel numbers in France.

In all other countries, radio channels from 0-7 may be programmed if there are no specific local telecommunication restrictions for the 2.4 GHz ISM-band.

\* WCU-3, WMU-3, the WMU-2 supports „Yellow“ Radio only

### 5.3 Selecting the radio channel (“White Radio”)

The new “White” radio has, aside from being available, the advantage of offering more robust transmission through direct sequence spread-spectrum and adjacent channel rejection technologies. Thus the “White” radio is less prone to interference from other wireless devices and can better co-exist with WLAN devices on the set.

The “White” radio modem in the WCU-3 utilises a different transmission scheme compared to the “Yellow” radio, therefore it is connecting to other “White” radio equipment only.

To establish a connection of one or more Wireless Hand Control Units\* (a maximum of three per radio channel is possible), the WCU-3 must be set to the same radio channel as the camera or the Motor Control Unit.

*Please refer to Section 3.2 for unit’s compatibility.*

It is not possible to control more than one motor control unit with one WCU-3.

Select the radio channel by pushing the jog-wheel at the unit’s lower side and select the Channel Menu. Refer to Section 4.1 for details.

\* WCU-3, WMU-3

Frequency range is the ISM 2.4 GHz. Modulation scheme used is DSSS (Direct Sequence Spread Spectrum).

ARRI Ch. Nr.	Frequency
0	2,410 GHz
1	2,415 GHz
2	2,430 GHz
3	2,435 GHz
4	2,450 GHz
5	2,455 GHz
6	2,470 GHz
7	2,475 GHz

In case two remote systems with white antenna washer must work side by side on different channels, it is recommended to set one of the systems to even channel and the other system to a neighbor - odd - channel number.

## Channel selection on motor control units:

Use the rotary channel selection knob on the LDB-2 (Lens Data Box), the FEM-2, the UMC-3(A) or ARRIFLEX 416 plus(HS).

Selector switch number 9 switches the radio modem off, number 8 is reserved for special purposes.

Press the LCS button on the ALEXA Plus/Studio, and select the same channel as on the WCU-3.

For a detailed description of the radio channel setting on units other than the WCU-3 please refer to the respective operation manual.

## Radio connection troubleshooting

- incorrect modem type ("Yellow" - "White" mixed-up)
- wrong channel setting - channel mismatch
- broken antenna or dirty antenna socket on partner units
- too long or too short distance to foreign party radio units, depends on local conditions
- interfering (illegal) foreign party transmitters
- another WCU-3 already drives the selected lens motor

## Control troubleshooting

- Axis lost: configuration has been changed while the units have been powered-on -> re-power and calibrate
- Focus or Iris not available in a separate control system: set both Focus and Iris to Knob control on their respective control units and re-power the units
- Jerky motor drive: mixed-up LCS connections for old (-1/2) and new (-3) hand units or motors (see page 22)

## 5.4 Optional Zoom Control

Connecting the ZMU-3(A) via cable KC 129-S and the WCU-3 to ZMU-3 bracket (*refer to page 10 for order numbers*), the WCU-3 may be expanded to a three axis lens control system. The ZMU-3(A) will be powered from the WCU-3 battery in wireless mode.

Only a ZMU-3(A) may be supplied from the WCU-3 battery in wireless operation. Any other connected unit must have its own power supply.

## Sample configurations - Radio controlled operation

ALEXA Plus/Studio  
 D21+FEM-2 + URM-3  
 ARRIFLEX 435 Adv. + FEM-2 + URM-3  
 ARRIFLEX 435 Xtreme  
 ARRIFLEX 416 Plus  
 ARRICAM LT/ST + LDB-2\*

lens motors  
 CLM-2 or CLM-3

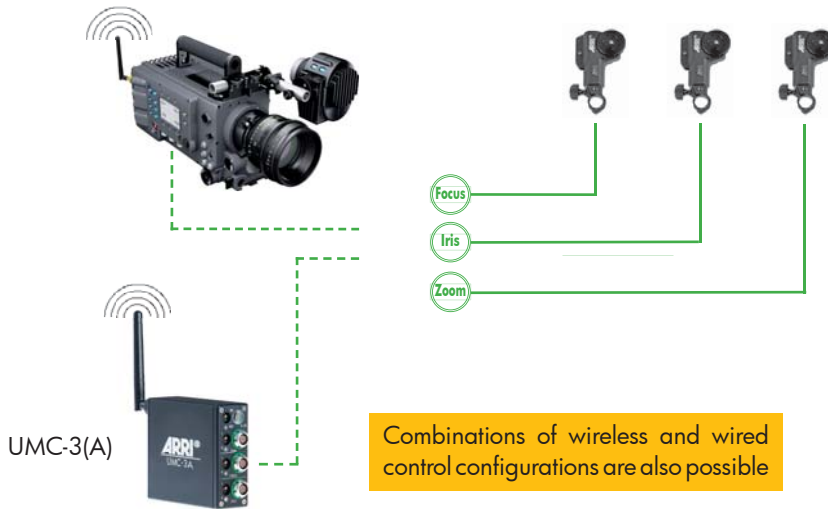

Combinations of wireless and wired control configurations are also possible

\* ARRICAM + LDB (any type) do not support CLM-3 lens motors

### 3-axis motor control with separate units 2x WCU-3 + ZMU-3(A)+WZE



Knob controls **Focus**



WCU-3 OPTIONS Screen



Knob controls **Iris**



WCU-3 OPTIONS Screen



**Zoom**

ZMU-3(A) + WZE

### 3-axis compact motor control 1x WCU-3 + ZMU-3(A)



## 5.5 Wired setup

The WCU-3 also allows hard-wired operation via the ARRI LCS-bus. The WCU-3 may be connected to any supported camera, motor controller or lens motor through any standard LCS cable.

The “cable”  symbol in the display’s status line appears, when an external power supply is detected, and “**Hardwire**” replaces the radio information. The radio module shuts-off automatically, regardless of its channel setting.



**Note:** *The WCU-3’s battery will NOT be charged through any external power supply!*

The WCU-3 provides two independently controlled LCS sockets. Do not use -1/-2 and -3 accessory units within the same LCS chain!

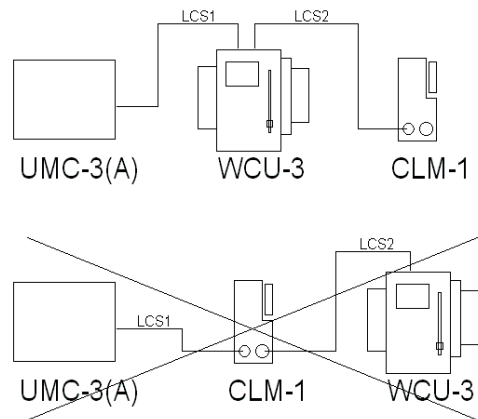

## Sample configurations - wired operation



ALEXA Plus/Studio  
D21+FEM-2 (+ URM-3)  
ARRIFLEX 435 Adv. + FEM-2 (+ URM-3)  
ARRIFLEX 435 Xtreme  
ARRIFLEX 416 Plus  
ARRICAM LT/ST + LDB-2\*

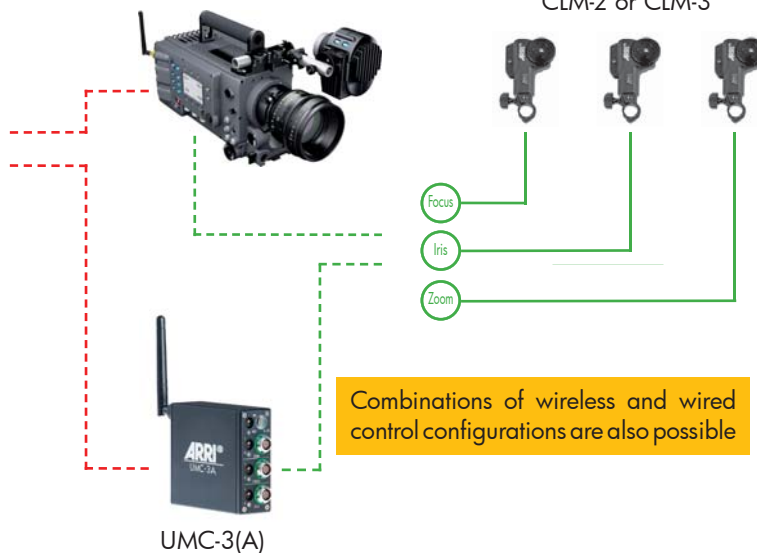

- K4.41395.0 LC-Z1-S LCS cable 3,5m (11ft)
- K4.41397.0 LC-M1-Sp-S LCS spiral cable
- K2.41389.0 LC-E1 LCS Cable Drum Extension 75m (250ft), use with LC-Z1-S
- K2.65159.0 KC 129-S WCU-3 to ZMU-3 cable for use with WCU-3 bracket
- K2.65009.0 KC 92-S LCS to ZMU-3 cable 0,8m (2,5ft)
- K2.65010.0 KC 93-S LCS to ZMU-3 cable 10m (30ft)

\* ARRICAM + LDB (any type) do not support CLM-3 lens motors

## LCS-Supported Units

### Cameras:

ARRIFLEX 416 PLUS (HS)

ARRIFLEX 435 Advanced + FEM-2

ARRIFLEX 435 Xtreme

ARRICAM + LDB-ST/-LT

D21 + FEM-2

ALEXA Plus/Studio

### Accessories:

UMC-1

UMC-3(A)

ZMU-1/-2/-3(A)

CLM-1



## 5.6 Knob Friction Adjustment

A unique feature of the WCU-3 is its very smooth knob action. Additionally, the friction is user adjustable.

Remove the knob's rubber ring. Open the three cross-headed countersunk screws that are accessible now. Pull-off the knob cover.

Now you have access to the friction adjustment. Release the knurled head screw and rotate the whole assembly clockwise for stronger friction or counterclockwise for easier action. Fasten the knurled head screw again, when the desired setting is found.



**NEVER** open any other screw of this assembly. The knob encoder may become misaligned or damaged, resulting in the unit having to be returned to the factory for a costly re-adjustment or encoder replacement.

knurled head screw for  
friction adjustment

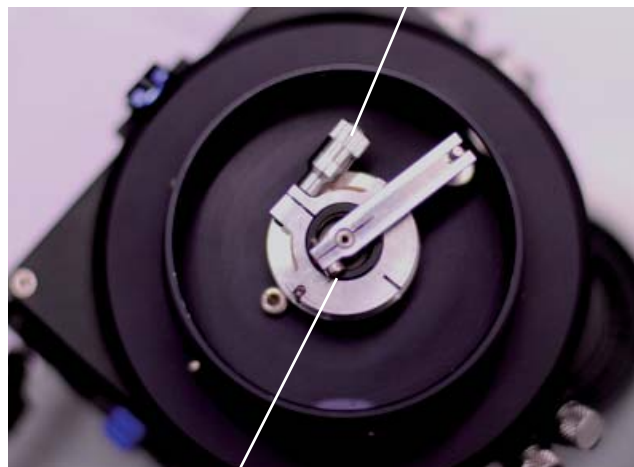

**NEVER** open this screw!

## 6. Battery Maintenance

The following batteries are recommended for use with the WCU-3:

SONY NP-FM Series (e.g. NP-FM 500H)

Recommended Charger:

SONY BC-VM50

For safety purposes, only use the recommended charger and battery types.

Please also take note of the following directives for battery handling:



Do not incinerate



Do not expose to temperatures beyond -20 to +50°C (-4 to +122°F)



Do not disassemble

Replace or re-charge the battery, if the “Low Battery” message on the WCU-3 Status Screen appears.



The charger must only be used indoors. Do not expose it to humidity or high temperatures.

*Note: For achieving full battery capacity, leave the battery for about one hour in the charger after the charge LED has gone out.*

From time to time discharge and re-charge the battery completely to maintain full long-term capacity.



Defective batteries must not be thrown into domestic waste, but disposed of onshore in a safe manner consistent with all applicable regulations.

## 7. Specifications

### Operating temperature

-20 to +50 °C ( -4 to +122°F )

### Operating voltage

7.2V Li-Ion battery

### Typ. current consumption

165mA @ 7,2V with radio, backlight "off"

175mA @ 7,2V with radio, backlight "high"

### Dimensions ( h \* w \* d ) with antenna

147\*132\*109mm (5.8\*5.2\*4.3in)

### Weight

800g (25.7oz) without battery

730g (28.2oz) with battery

## Declaration of Conformity

We, Manufacturer  
 ARRI CINE + VIDEO GERÄTE GmbH  
 Pottendorferstraße 25-27/3/2/1  
 A-1120 Wien  
 declare that the product  
 Wireless Control Unit

### WCU-3

is in conformity with

DIN EN 55103-1: 1997-06  
 DIN EN 55103-2: 1997-06  
 DIN EN61000-3-2: 2006-10  
 DIN EN61000-3-3: 2006-06  
 DIN EN 60065: 2003-01

additional Certification of built in RF-modem AC4424I-100

EN 300 328-1 V1.3.1: 2001-12  
 EN 300 328-2 V1.2.1: 2001-12  
  
 EN 301 489-1 V1.3.1: 2001-09  
 EN 301 489-17 V1.1.1: 2000-09  
 FCC Rule Parts 15 C

Date:  
 2008-07-07

Signature



Ing. Walter Trauringer

## Declaration of Conformity

We, Manufacturer  
 ARRI CINE + VIDEO GERÄTE GmbH  
 Pottendorferstrasse 25-27  
 A-1120 Wien  
 declare that the product  
 Wireless Zoom Extension Unit

### WCU-3

WHITE marked  
 is in conformity with

DIN EN 55103-1: 1997-06  
 DIN EN 55103-2: 1997-06  
 DIN EN61000-3-2: 2006-10  
 DIN EN61000-3-3: 2006-06  
 DIN EN 60065: 2003-01

Modular Certification of built in RF-modem ARRI EMIP100

EN 300 328 V1.7.1: 2006-10

EN 301 489-1 V1.8.1: 2008-04  
 EN 301 489-17 V2.1.1: 2009-05

FCC CFR 47 Part 15: 10-2009  
 Listed under FCC ID: Y7N-EMIP100

RSS-Gen Issue 2: June 2007  
 RSS-210: Issue 7: June 2007  
 Listed under IC: 9482A-EMIP100

Date:  
 2011-05-02

Signature

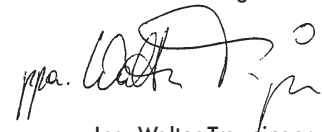

Ing. Walter Trauringer

## 8. ARRI Service

WorldWide Service Network

### Active Hotlines:

#### Munich, Germany

Arnold & Richter Cine Technik  
+49 89 3809 2121  
service@arri.de

#### London, Great Britain

ARRI CT Limited  
+44 1895 457 051  
service@arri-ct.com

#### Rome, Italy

ARRI Italia S.r.l.  
+39 335 749 00 70  
service@arri.it

### Passive Hotlines:

#### Hong Kong

ARRI Asia Limited  
+852 2537 4266  
service@arriasia.hk

#### Sydney, Australia

ARRI Australia Pty Ltd  
+61 2 9855 4305  
service@arri.com.au

#### Burbank, USA

ARRI Inc. West Coast  
+1 877 565 2774  
service@arri.com

#### New York, USA

ARRI Inc. East Coast  
+1 877 565 2774  
service@arri.com

#### Toronto, Canada

ARRI Canada Limited  
+1 416 255 3335  
service@arri.com

technical data is subject to change without notice

© ARRI 2012

WCU-3 User Manual

ARRI Order no. K5.67999.0



ARNOLD & RICHTER CINE TECHNIK

Türkenstr. 89 D-80799 München

Phone +49 (0)89 - 3809-0 Fax +49 (0)89 - 3809-1244

[www.arri.com](http://www.arri.com)