

WM-3004HD

HD LCD Waveform Monitor

Instruction Manual

August 25, 2003

Ver.1.00

ASTRODESIGN, Inc.

CONTENTS

INTRODUCTION	3
SAFETY PRECAUTIONS	4
CHAPTER 1 CONCERNING THE WM-3004	7
CHAPTER 2 PARTS AND THEIR FUNCTIONS	8
2.1 WM-3004 front panel view and parts	8
2.2 WM-3004 rear panel view and parts	10
CHAPTER 3 OPERATION	12
3.1 Connections	12
3.2 Usage	12
3.3 Operation and how to use the switches	13
3.3.2 PICTURE2 mode	21
3.3.3 PICTURE3 mode	24
3.3.4 WAVEFORM mode	26
3.3.5 VECTOR mode	36
3.3.6 STATUS mode	41
3.3.7 AUDIO mode	44
3.3.8 MENU mode	47
3.3.9 HELP mode	50
3.4 Installing and securing the monitor	50
CHAPTER 4 MAIN SPECIFICATIONS	51
4.1 Input formats	51
4.2 Input signal systems	52
4.3 Display system	52
4.4 Headphones output	52
4.5 Concerning the adjustment values	53
4.6 Settings at initialization	55
4.6.1 Common setting items	55
4.6.2 Setting items by channel	56
4.7 General specifications	56
4.8 Outline drawings	57
CHAPTER 5 STANDARD AND OPTIONAL ACCESSORIES	58
5.1 Standard accessories	58
5.2 Optional accessories	58
NOTICE	59

INTRODUCTION

Thank you very much for purchasing this model WM-3004 HD LCD waveform monitor. This manual contains details on the operation procedures to be followed when the WM-3004 is used, the checkpoints and precautions to be observed, and so on.

Improper handling may result in malfunctioning. Before using the WM-3004, please read through these instructions to ensure that you will operate the monitor correctly.

After reading through the manual, keep it in a safe place for future reference.

SAFETY PRECAUTIONS

WARNING

Concerning the monitor

- Do not subject the monitor to strong shocks or throw it around. Doing so may cause the liquid crystal to leak and/or the monitor to malfunction, rupture, generate heat and cause a fire.
- Do not use the monitor wherever there is a risk of ignition or explosions.
- Do not place the monitor inside a microwave oven or other heating or cooking appliance or pressure vessel. Doing so may cause heat or smoke to be generated in the monitor, combustion and/or damage to the circuit components.
- Inside the monitor are some high-voltage parts: since exposure to these parts may result in electric shocks or burns, refrain from disassembling, repairing or remodeling the monitor.
- If a thunderstorm should occur while the monitor is being used outdoors, immediately turn off its power, disconnect the power cable and battery from the main unit, and move the monitor to a safe place.

Concerning the power cord

- Always take hold of the molded part of the plug when disconnecting the power cord.
- Do not apply force to bend the power cord or bunch it up for use. This may cause a fire.
- Do not place heavy objects on top of the power cord. This may damage the cord, causing a fire or electrical shock.

Concerning foreign matter

- Do not spill liquids inside the monitor or drop inflammable objects or metal parts into it. Operating the monitor under these conditions may cause a fire, electric shocks and/or malfunctioning.

CAUTION

Concerning the power supply

- Use a supply voltage within the range of 10V-18V DC for the monitor.
- Do not turn the power back on immediately after having turned it off. Doing so can cause malfunctioning.

Concerning the liquid crystal

- Due to the nature of liquid crystal, some picture elements may be missing (bright spots, dark spots, etc.) at times.
- Do not touch any liquid crystal which has leaked from the liquid crystal panel.
If the liquid crystal panel has been damaged by mistake and the liquid (liquid crystal) inside has leaked out, keep the liquid away from your mouth and skin and do not inhale its odors.
In the event that liquid crystal has made contact with your eyes or mouth, use water to rinse it off immediately. If it has come into contact with your skin or clothing, wipe it off immediately with alcohol, and then rinse it off with soap. Leaving it in place may damage your skin or clothing.
- Exercise care with the glass of a broken liquid crystal panel. If the panel has broken, be careful not to cut your hands on the glass shards. If you should touch an area where the glass has broken off, you may injure yourself.
- The LCD panel is a high-precision component and, as such, the following care must be taken in its handling.
 - 1) Wiping the panel's surface with benzine, paint thinners, etc. will cause a deterioration in its quality.
 - 2) If water (salty water) is left on the display surface, discoloration and staining will result.
 - 3) Exposing the panel directly to ultraviolet rays for an extended period causes the deflection panel to turn brown, in turn causing the contrast to drop and other forms of deterioration to develop in the display quality.
 - 4) Moisture inside the monitor due to condensation, etc. may cause unevenness in the colors.
 - 5) Directly tapping the surface or bumping it into objects may crack the panel, etc.
 - 6) Do not attempt to disassemble the panel since leaking liquid crystal may make contact with your skin, which is hazardous.
- Handle the liquid crystal protective panel carefully.
Gently wipe off any fingerprints or dirt on the liquid crystal protective panel with a cleaning agent used to clean office automation equipment. Rubbing the panel with too much force may mark or damage the panel.

Concerning impact

- This is a precision instrument and, as such, subjecting it to impact may cause malfunctioning. Take special care when moving the monitor.
- Do not drop the monitor.

Concerning installation and operation locations

- Installing the monitor in the following kinds of locations may cause malfunctioning and/or accidents.
 - 1) Locations with an ambient temperature outside the range of 0 -40 degrees Celsius (see Note 1)
 - 2) Locations with an ambient humidity outside the range of 30-80% RH
 - 3) Locations in the vicinity of an air conditioner or subject to rapid temperature changes or the formation of condensation
 - 4) Locations exposed to direct sunlight (see Note 2)
 - 5) Locations exposed to corrosive gases or high concentrations of dust
 - 6) Locations where strong magnetic fields are generated
 - 7) Locations where the monitor may be splashed with water, oil, chemicals, etc.
 - 8) Locations to which vibrations are transmitted from the floor
 - 9) Unstable locations
- Take good care to meet the following conditions in order to ensure that the monitor will be used properly.
 - 1) Do not place heavy objects such as another monitor directly on top of the monitor.
 - 2) Avoid placing any objects around the monitor.
 - Note 1: When the surface temperature of the LCD panel exceeds 60 degrees Celsius, the panel's backlight and other parts may be damaged.
 - Note 2: Exposing the panel directly to ultraviolet rays for an extended period causes the deflection panel to turn brown, in turn causing the contrast to drop and other forms of deterioration to develop in the display quality.

When the monitor fails to operate properly

- When the image is not displayed properly, check the format settings.
- If  NoSignal appears on the screen even though input signals have been supplied, check the input settings and the format settings.
- If the front panel switches should fail to operate, check whether the LOCK switch is at the ON position.

When trouble or malfunctioning occurs

- In the unlikely event that trouble or malfunctioning should occur, contact your dealer or an Astrodesign sales representative.
- If trouble should occur in the LCD panel, the user will be charged for repairs and parts replacement even within the warranty period.

Concerning this manual

- It is strictly forbidden to copy this manual either in part or in its entirety without permission from Astrodesign.
 - 1) The contents and specifications of this manual are subject to change without notice for the purposes of improving quality.
 - 2) Although this manual has been prepared with painstaking care, the user is asked to contact Astrodesign if any ambiguities, mistakes, omissions or other shortcomings are noticed.

CHAPTER 1 CONCERNING THE WM-3004

The WM-3004 is a compact, lightweight and portable LCD waveform monitor which comes in handy for monitoring the pictures being shot during live broadcasts, on location or in studios, etc.

The camera battery is supported as the power supply so that pictures, waveforms and sound can be checked even in locations where difficulties have been encountered in the past in carrying in equipment.

A full range of functions is provided including functions for adjusting the brightness, contrast and chroma levels as well as functions for displaying markers.

Input signals in a total of 23 HDTV video formats are supported.

1.1 Outline of WM-3004

- 6.4-inch a-Si TFT LCD panel featured
- HD-SDI or YPbPr HD analog input signals (Y-on-sync) supported
- 23 different video formats supported
 - Standards supporting HD-SDI: SMPTE 292M, BTA-S004B standards complied with (1.485 Gbps SDI input)
 - Standards for analog input and supported formats: SMPTE 274M, SMPTE 296M, BTA-S001B standards complied with
- SDI IN (×2), SDI MONITOR OUT, HD analog input (ANALOG Y, ANALOG Pb, ANALOG Pr) and REF IN connectors provided
- Brightness, contrast, chroma, filter, monochrome, Y gamma adjustment functions
- Marker display functions (frame, center, 4:3, 13:9, 14:9, 2.35:1, 1.85:1, 1.66:1)
- Single-action operation of input channels, partial display/non-display of information, picture overlay and freeze/update selection using the switches on the front panel
- Lighting of red, green LEDs at top of screen by external contact supply-type tally inputs
- Automatic scanning of input signals possible
- Automatic 1/1.000 and 1/1.001 frame rate scanning and input signal detection functions
- CRC error detection function (during HD-SDI input) for input channels
- Functions for locking the panel switches and storing the setting values
- Light weight and compact size
- DC supply power input (10-18V)
- Camera battery supported

CHAPTER 2 PARTS AND THEIR FUNCTIONS

2.1 WM-3004 front panel view and parts

WM-3004 front panel view

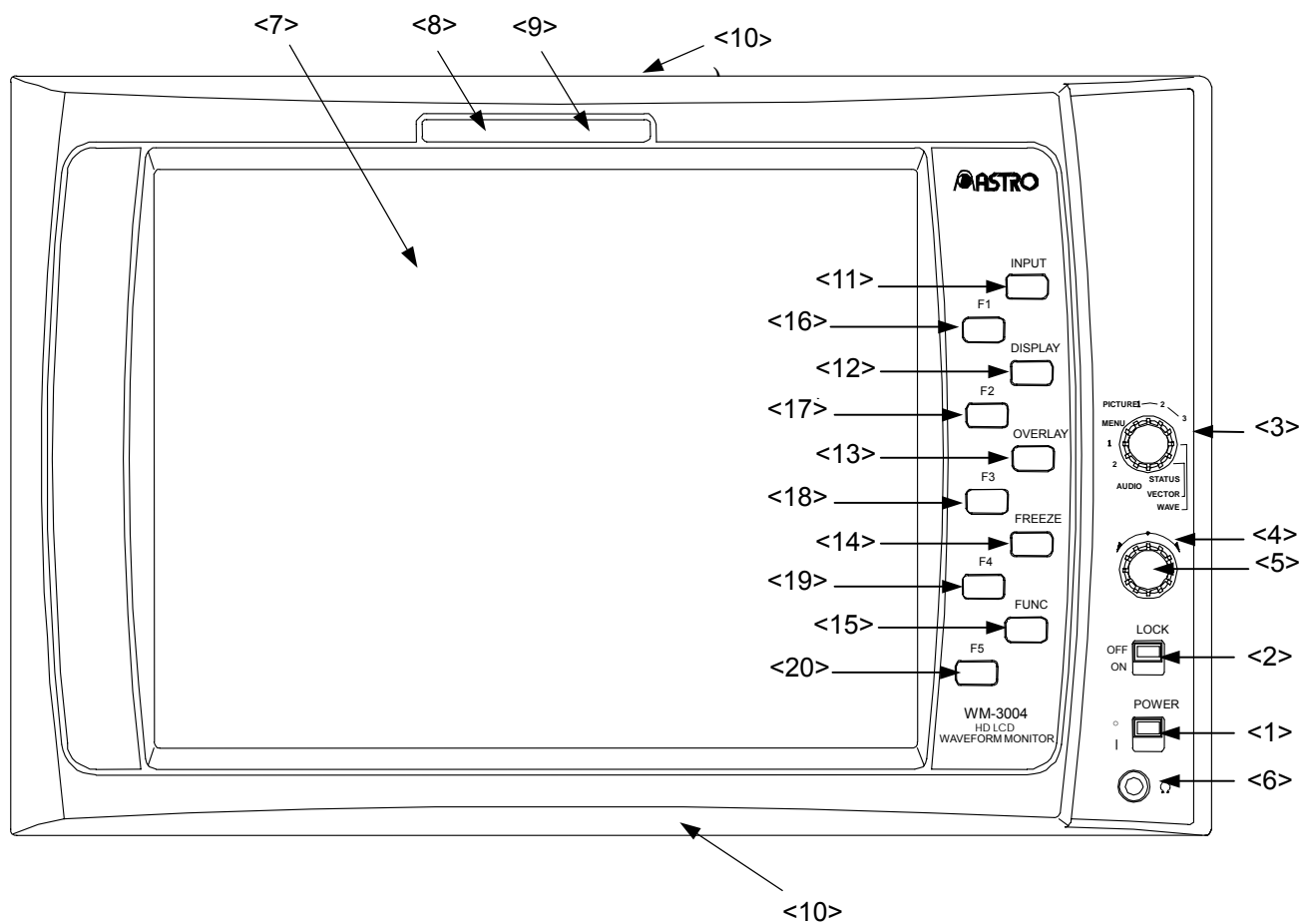

Front panel parts and their functions

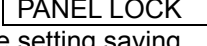
Number	Part	Description of function
<1>	Power switch/LED	This switch is used to turn the power ON and OFF. (Its LED lights up green while the power is supplied.)
<2>	LOCK switch/LED	This switch is used to lock the panel switches and save the setting values simultaneously.  Wait appears at the bottom right of the screen while the settings are being saved, and upon completion of the saving process,  PANEL LOCK appears. Do not turn off the power while the setting saving process is in progress. The saved settings are loaded when the power is turned on. (The LED of this switch lights up yellow while the panel switches are locked.)
<3>	Mode switch	This switch is used to select the monitor's mode. The mode is selected in the following sequence: PICTURE1 ↔ PICTURE2 ↔ PICTURE3 ↔ WAVEFORM ↑ ↓ MENU ↔ 1 ↔ 2 ↔ AUDIO ↔ STATUS ↔ VECTOR ↑ ↓
<4>	Adjustment dial	This dial is used to adjust and select the settings.
<5>	Setting switch	This switch is used to adjust and select the settings.
<6>	Headphone jack	The sound is output from this jack (diameter: 35 mm).
<7>	Liquid crystal display	The images appear on this display.
<8>	TALLY 1	Tally lamp (red): this is controlled by the rear panel tally connector (contact supply type).
<9>	TALLY 2	Tally lamp (green): this is controlled by the rear panel tally connector (contact supply type).
<10>	1/4-20UNC threaded hole	Threaded hole for a screw to anchor the monitor (used to anchor the monitor to a tripod, arm, etc.).
<11>	INPUT switch	This switch is used to select SDI A or SDI B for the input signals. When it is held down (for more than one second), analog signals are input.
<12>	DISPLAY switch	This switch is used to set whether the information is to be partially displayed on the screen or not displayed at all. When it is held down (for more than one second), the top and bottom of the screen are inverted.
<13>	OVERLAY switch	This switch is used to change the picture overlay settings. When it is held down (for more than one second), the color setting screen appears. (The color setting items differ according to the mode selected.)
<14>	FREEZE switch	This switch is used to select freeze or update. Freeze is released by switching the input signals or format. Bear in mind that if the input signals are cut off or their format has been changed in the freeze status, the correct data will not be output.
<15>	FUNC switch	This switch is used to select the function switches (switches F1 to F5).
<16>	F1 switch	The function of this switch is different depending on each menu which is selected.
<17>	F2 switch	The function of this switch is different depending on each menu which is selected.
<18>	F3 switch	The function of this switch is different depending on each menu which is selected.
<19>	F4 switch	The function of this switch is different depending on each menu which is selected.
<20>	F5 switch	The function of this switch is different depending on each menu which is selected.

2.2 WM-3004 rear panel view and parts

WM-3004 rear panel view

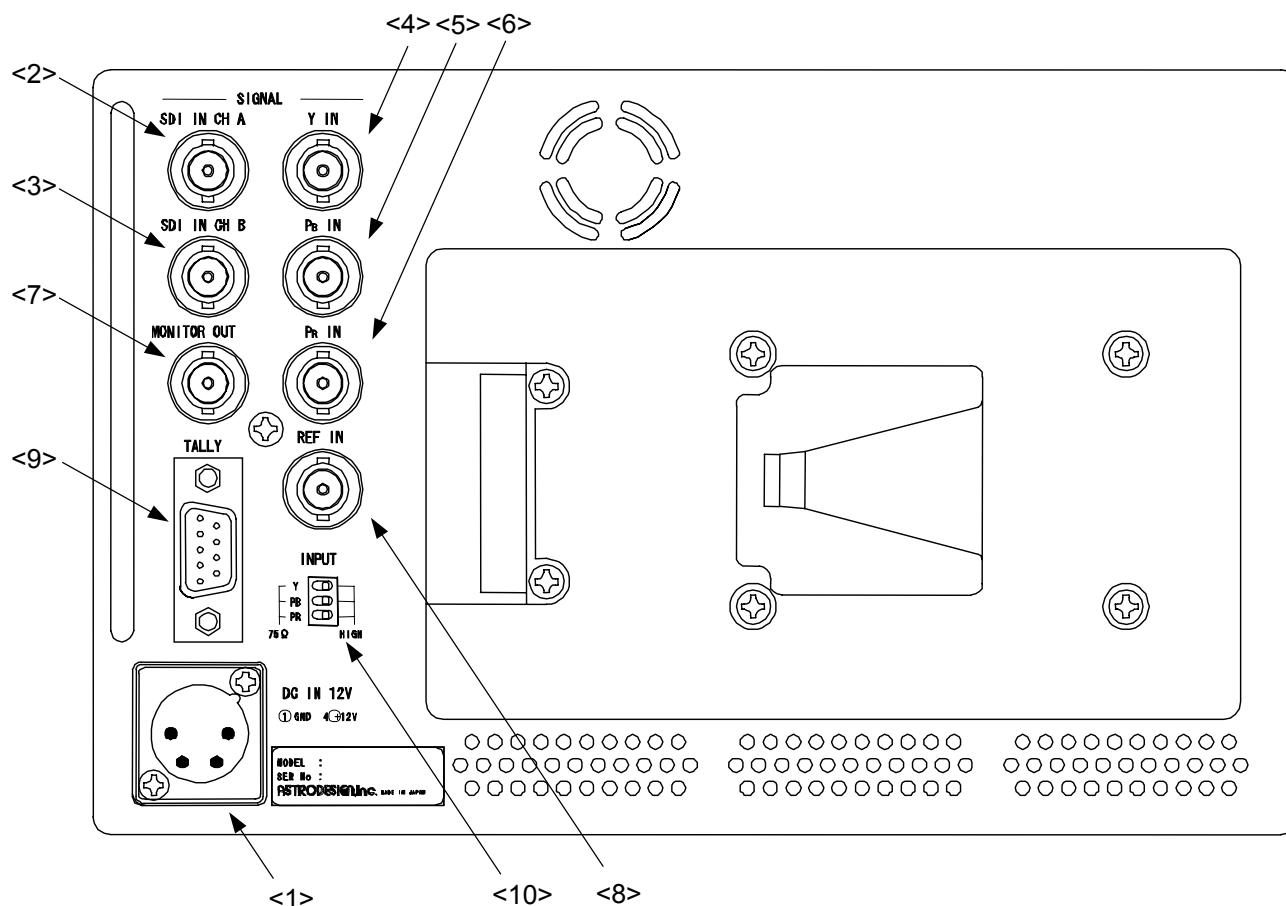

Names of rear panel parts

Number	Part	Description of function
<1>	Power socket (*1)	Cannon connector, DC power input socket (GND: pin 1; DC IN: pin 4).
<2>	SDI IN Ach	HD-SDI signal input connector.
<3>	SDI IN Bch	HD-SDI signal input connector.
<4>	Y IN	HD analog Y signal input connector; synchronization is provided by the Y signal in the case of analog inputs.
<5>	Pb IN	HD analog Pb (Cb) signal input connector.
<6>	Pr IN	HD analog Pr (Cr) signal input connector.
<7>	MONITOR OUT	Output connector for simplified monitoring of SDI input signals. SDI A SDI A images are output when the SDI A input is selected. SDI B images are output when the SDI B input is selected. SDI A images are output when the analog input is selected.
<8>	REF IN	Reference input signal connector (HD tri-level sync only).
<9>	TALLY connector (*2)	D-sub 9-pin (female)
<10>	Termination selector switch (*3)	This is used to enable or disable the 75Ω termination for the analog signals.

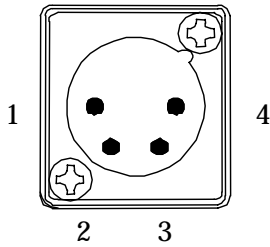
***1: Power socket (no. <1>)**

Pin No.	Function
1	GND
2	NC
3	NC
4	DC IN (10-18V)

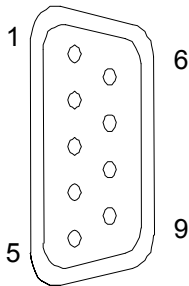
***2: TALLY connector (no. <9>)**

Pin No.	Function
1	GND
2	TALLY2 (green)
3	NC (reserved) (Note)
4	NC (reserved) (Note)
5	NC (reserved) (Note)
6	GND
7	TALLY1 (red)
8	NC (reserved) (Note)
9	GND

When GND and pin 2 are shorted, the green tally lamp lights; when GND and pin 7 are shorted, the red tally lamp lights.

(Note) Do not connect anything to the pins marked NC (reserved). Doing so may cause malfunctioning.

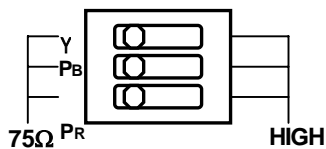
***3: Termination selector switch (no. <10>)**

Switch	Setting	
	Left	Right
Y	Y 75Ω termination	No Y termination
PB	PB 75Ω termination	No PB termination
PR	PR 75Ω termination	No PR termination

As shown in the figure above, the initial setting positions starting with the top one first are left (Y 75Ω termination), left (Pb 75Ω termination) and left (Pr 75Ω termination).

CHAPTER 3 OPERATION

3.1 Connections

This section describes how to connect the WM-3004.

(1) Connecting the power supply

Connect the Cannon connector of the AC/DC adapter to the WM-3004's power socket. Check the shape of the connector and socket before use.

(2) Connecting the input signals

- When SDI signals are to be input:
When SDI signals are to be input, use BNC coaxial cables to make the connections to the SDI IN connectors.
The SDI IN connectors are where the SDI signals are input; MONITOR OUT is an output connector which is used for the simplified monitoring of the SDI input signals. Supply serial input signals complying with the BTA S-004B standard as the HD-SDI input signals. Use a coaxial cable (5C-FB or its equivalent) which can handle the 1.5 GHz band.
- When analog signals are to be input:
When HD analog signals are to be input, input the YPbPr signals to the respective analog connectors.
Input YPbPr signals complying with the BTA S-001B standard as the HD analog input signals.
Synchronization is obtained from the Y signal.
- Precaution to be observed in the WAVEFORM or VECTOR mode:
When the waveforms or vectors of analog signals are to be displayed, noise with a maximum level of $\pm 30\text{mV}$ may occur inside the WM-3004. Therefore, do not use the monitor for measurements requiring a higher precision.
- Precaution to be observed in the STATUS mode:
Since the WM-3004 employs an 8-bit A/D converter, 00 is always output for the lower 2 bits of the 10 bits displayed in the STATUS mode.

3.2 Usage

A protective film is attached to the surface of the LCD panel. Peel it off before using the WM-3004.

After checking the connections, turn on the power of the WM-3004 using the POWER switch on the front panel. The POWER LED lights, and images are displayed.

If the POWER LED fails to light, check the connections again.

To conduct the simplified monitoring of the SDI input signals, use the MONITOR OUT connector.

The analog input signals will not appear on the monitor if no sync signals are contained in the Y signal. Check the ARIB BTA S-001 and other standards for the levels, etc.

If no input signals are supplied, the image area appears all black, and  NoSignal is displayed on the screen.

3.3 Operation and how to use the switches

This section describes the displays which appear on the WM-3004 screen and the setting methods involved.

<<Screen displays>>

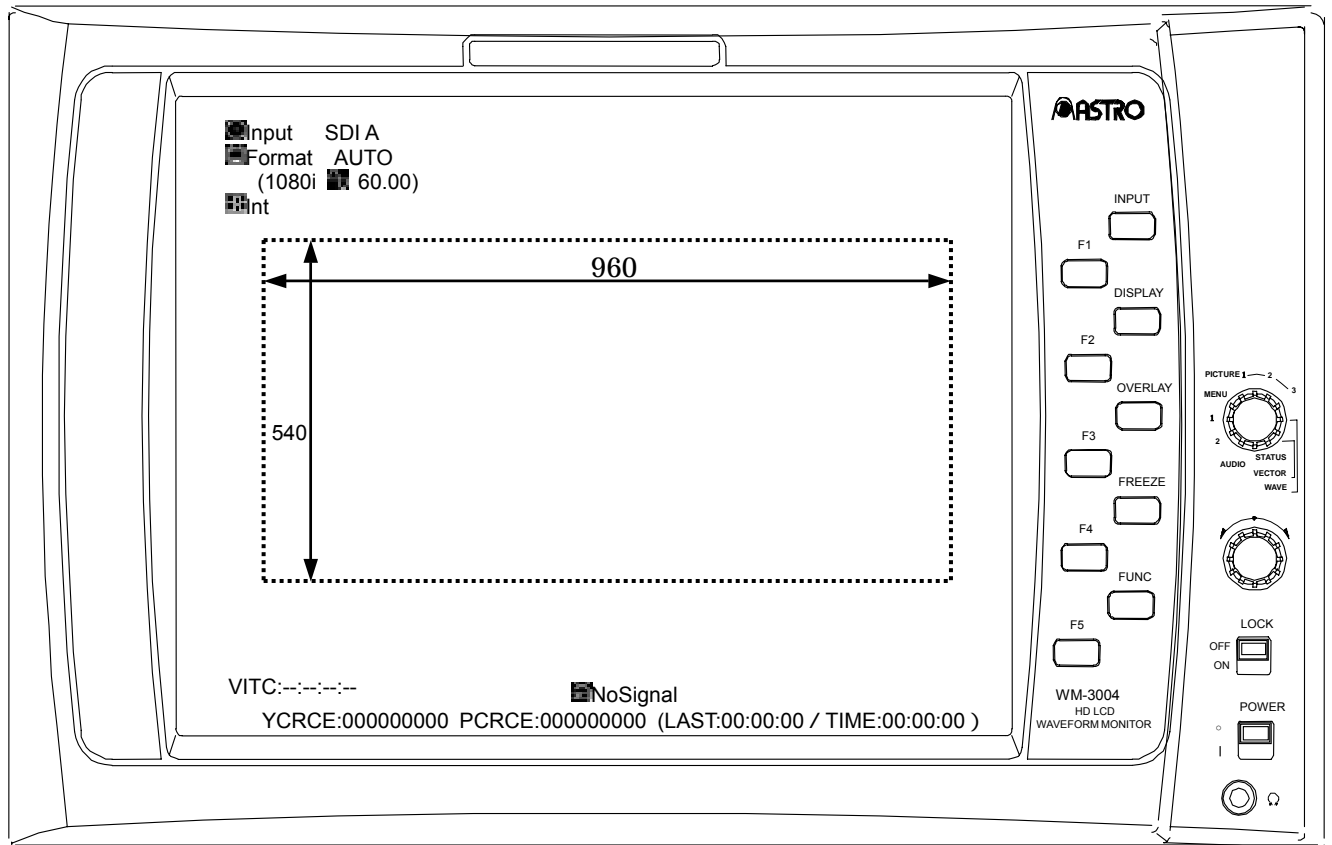

Note: The area enclosed by the dotted lines in the figure is the image area. Normally, its size is 960 × 540 pixels.

[Description of modes]

The modes are described in the sections listed below.

PICTURE1 mode (refer to section 3.3.1)

PICTURE2 mode (refer to section 3.3.2)

PICTURE3 mode (refer to section 3.3.3)

WAVEFORM mode (refer to section 3.3.4)

VECTOR mode (refer to section 3.3.5)

STATUS mode (refer to section 3.3.6)

AUDIO mode (refer to section 3.3.7)





















2 mode (refer to section 3.3.3)

HELP mode (refer to section 3.3.9)

This mode is indicated as "1" in terms of the position set by the mode switch on the main unit.

































MENU mode (refer to section 3.3.8)

[Description of screen displays]

Item	Description	Display modes
 Input	Displayed here is the input channel (SDI A, SDI B or Analog) which has been selected by the INPUT switch.	P1 · P2 · W · V · S · A · M
 Format	The selected format is displayed here. Indicated within the parentheses on the line below are the input signal format and field (or frame) frequency. When analog input has been selected even if 1035 input signals are supplied, these signals will be identified as 1080 signals. If no signals are input (when  NoSignal appears on the screen), "*" appears. (For details on the formats, refer to Chapter 4.) If the format which has been set and the format of the actual input signals differ,  Format appears in red.	P1 · P2 · W · V · S · A · M
 (Reference)	The input reference signal is displayed here.  Int denotes an internal sync signal;  Ref denotes an external sync signal.	P1 · P2 · W · V · S · A · M
 NoSignal	If the signal which has been set and the actual input signals differ,  NoSignal appears in red.	P1 · P2 · P3 · W · V · S · A · M
VITC	The time code (VITC) is displayed here.	P1 · P2 · P3 · W · V · S · A · M
 YCRCE	This is where the Y signal is checked for CRC errors and the number of errors is displayed. The CRC errors are counted even in the freeze status. When an error is found,  YCRCE appears in red for one second. Note: The CRC errors are not counted when analog signals are input. Neither are they counted for one second after the input signals have been changed by the INPUT switch.	P1 · P2 · W · V · S · A · M
 PCRCE	This is where the Pb and Pr signals are checked for CRC errors and the number of errors is displayed. The CRC errors are counted even in the freeze status. When an error is found,  PCRCE appears in red for one second. Note: The CRC errors are not counted when analog signals are input. Neither are they counted for one second after the input signals have been changed by the INPUT switch.	P1 · P2 · W · V · S · A · M
 LAST	The time elapsed since the last error was found is displayed here.	P1 · P2 · W · V · S · A · M
 TIME	The time elapsing after the WM-3004 was started or error count was reset is displayed here.	P1 · P2 · W · V · S · A · M
 Freeze	This indicates the freeze status. When the freeze status is established,  Freeze appears in blue.	P1 · P2 · P3 · W · V · S · A · M
 Filter	This indicates whether the video filter is ON or OFF.	P1 · P2
 Mono	This indicates whether monochrome is ON or OFF.	P1 · P2
 FRC	This indicates whether the 8-bit processing using the frame rate control is ON or OFF.	P1 · P2

Abbreviations used in display mode column:



P1···PICTURE1, P2···PICTURE2, P3···PICTURE3, W···WAVEFORM, V···VECTOR, S···STATUS, A···AUDIO, M···MENU

Item	Description	Display modes
 G	This indicates whether the input video green (G) signal is to be displayed.	P1 · P2
 B	This indicates whether the input video blue (B) signal is to be displayed.	P1 · P2
 R	This indicates whether the input video red (R) signal is to be displayed.	P1 · P2
 (Marker)	This indicates a list of the usable markers. The currently selected marker is highlighted.	P1 · P2
 Y-Gamma	This indicates the Y gamma setting.	P1 · P2
 Bright	This indicates the brightness setting.	P1 · P2
 Contrast	This indicates the contrast setting.	P1 · P2
 Pb(Cb)	This indicates the Pb (Cb) setting.	P1 · P2
 Pr(Cr)	This indicates the Pr (Cr) setting.	P1 · P2
 YPbPr / GBR	This indicates the waveform display method.	W
 Parade / Overlay	This indicates the parade display or overlay display for the waveforms.	W
 1H / 2H / 1F / 2F	This indicates the sweep 1H/2H/1F/2F switching.	W
 M x1 / x2 / x4	This indicates the MAG magnification rate.	W
 G x*. **	This indicates the GAIN magnification rate.	W
 dT	This indicates the H cursor difference. It does not appear unless the H cursor is displayed.	W
 d% / dV	This indicates the V cursor difference. It does not appear unless the V cursor is displayed.	W
 Field 1 / Field 2	This indicates the currently displayed field. It does not appear unless  LineSelect is set to ON.	W · V · S
 Line (Field)	This indicates the line number in the currently displayed field. It does not appear unless  LineSelect is set to ON.	W · V · S
 Line (Frame)	This indicates the line number. It does not appear unless  LineSelect is set to ON.	W · V · S
 Sample	This indicates the sample number.	S
 x 1.00	This indicates the GAIN magnification rate.	V
 Position	This indicates the position of the displayed waveform.	W
 Volume	This indicates the volume level.	A
 L:xCH R:xCH	This indicates the embedded audio channels through which the sound is output.	A
 Information	This indicates the color of the characters.	P1 · P2 · P3 · W · V · S · A · M
 Marker	This indicates the color of the markers.	P1 · P2 · P3
 Scale	This indicates the color of the scale.	W · V · S · A
 Waveform	This indicates the color and brightness of the waveforms.	W
 Cursor	This indicates the color of the cursors.	W · V · S
 Vector	This indicates the color and brightness of the vectors.	V
Status	This indicates the color of the status.	S · A

Abbreviations used in display mode column:

P1···PICTURE1, P2···PICTURE2, P3···PICTURE3, W···WAVEFORM, V···VECTOR, S···STATUS, A···AUDIO, M···MENU

[Description of operations]

Switch	Description of function
INPUT switch	This switch is used to select the SDI A or SDI B input signals. When it is held down (for more than one second), analog signals are input. If the freeze status is established at this time, it is released.
DISPLAY switch	This switch is used to set whether the information is to be partially displayed on the screen or not displayed at all. When it is held down (for more than one second), the top and bottom of the screen are inverted.
OVERLAY switch	This switch is used to perform the picture overlay settings. In the PICTURE1, PICTURE2 or PICTURE3 mode, it has no effect since a picture is always displayed. When it is held down (for more than 1 second), the color setting screen appears. (The color setting items differ according to the mode selected.)
FREEZE switch	This switch is used to select freeze or update. Freeze is released by switching the input signals or format. Bear in mind that if the input signals are cut off or their format has been changed in the freeze status, the correct data will not be output. CRC errors are counted even while the freeze status is established.
FUNC switch	This switch is used to select the function switches (switches F1 to F5).
LOCK switch	All key operations are canceled, and the values for the setting items in section 4.6 are saved.  Wait appears at the bottom right of the screen while the settings are being saved, and upon completion of the saving process,  PANEL LOCK appears. Do not turn off the power while the setting saving process is in progress. The saved settings are loaded and established when the power is turned on.

3.3.1 PICTURE1 mode

3.3.1.1 Picture adjustments 1 screen

<<Functions>>

The input images can be displayed, and the following video adjustments can be undertaken.



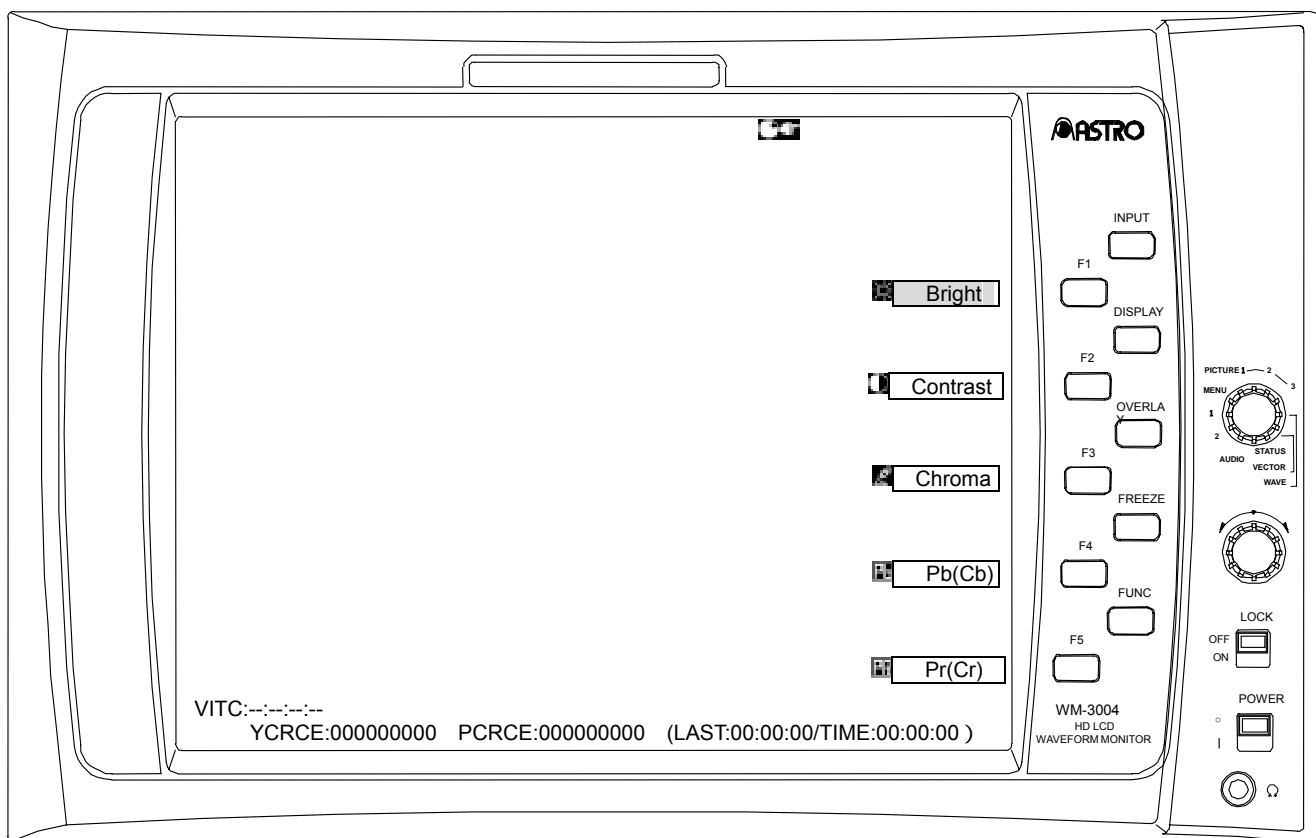

- Brightness
- Contrast
- Chroma
- Pb (Cb)
- Pr (Cr)

<<Screen>>

Input	SDI A	Filter ON	FRAME CENTER	Bright	0.00%
Format	AUTO	Mono	OFF 4:3 13:9 14:9	Contrast	100.0%
(1080i	60.00)	FRC	OFF 2.35:1 1.85:1 1.66:1	Pb(Cb)	100.0%
nt		G B R	Y-Gamma	Pr(Cr)	100.0%



[Description of operations]

Switch	Description of function
FUNC switch	This switches the display to the picture adjustment 2 screen. (Refer to section 3.3.1.2)
F1 switch  Bright	Press this to adjust the brightness using the adjustment dial. Refer to section 4.5. (Variable range: -50.00% to +50.00%)
F2 switch  Contrast	Press this to adjust the contrast using the adjustment dial. (Variable range: 0.0%-200.0%) When the setting switch is pressed, the contrast is restored to the initial value.
F3 switch  Chroma	Press this to adjust the chroma value using the adjustment dial. (Variable range: 0.0%-200.0%) When the setting switch is pressed, the chroma is restored to the initial value.
F4 switch  Pb(Cb)	Press this to adjust the Pb (Cb) value using the adjustment dial. (Variable range: 0.0%-200.0%) When the setting switch is pressed, Pb (Cb) is restored to the initial value.
F5 switch  Pr(Cr)	Press this to adjust the Pr (Cr) value using the adjustment dial. (Variable range: 0.0%-200.0%) When the setting switch is pressed, Pr (Cr) is restored to the initial value.

3.3.1.2 Picture adjustments 2 screen

<<Functions>>

The input images can be displayed, and the following video adjustment can be undertaken.

- Y gamma

<<Screen>>

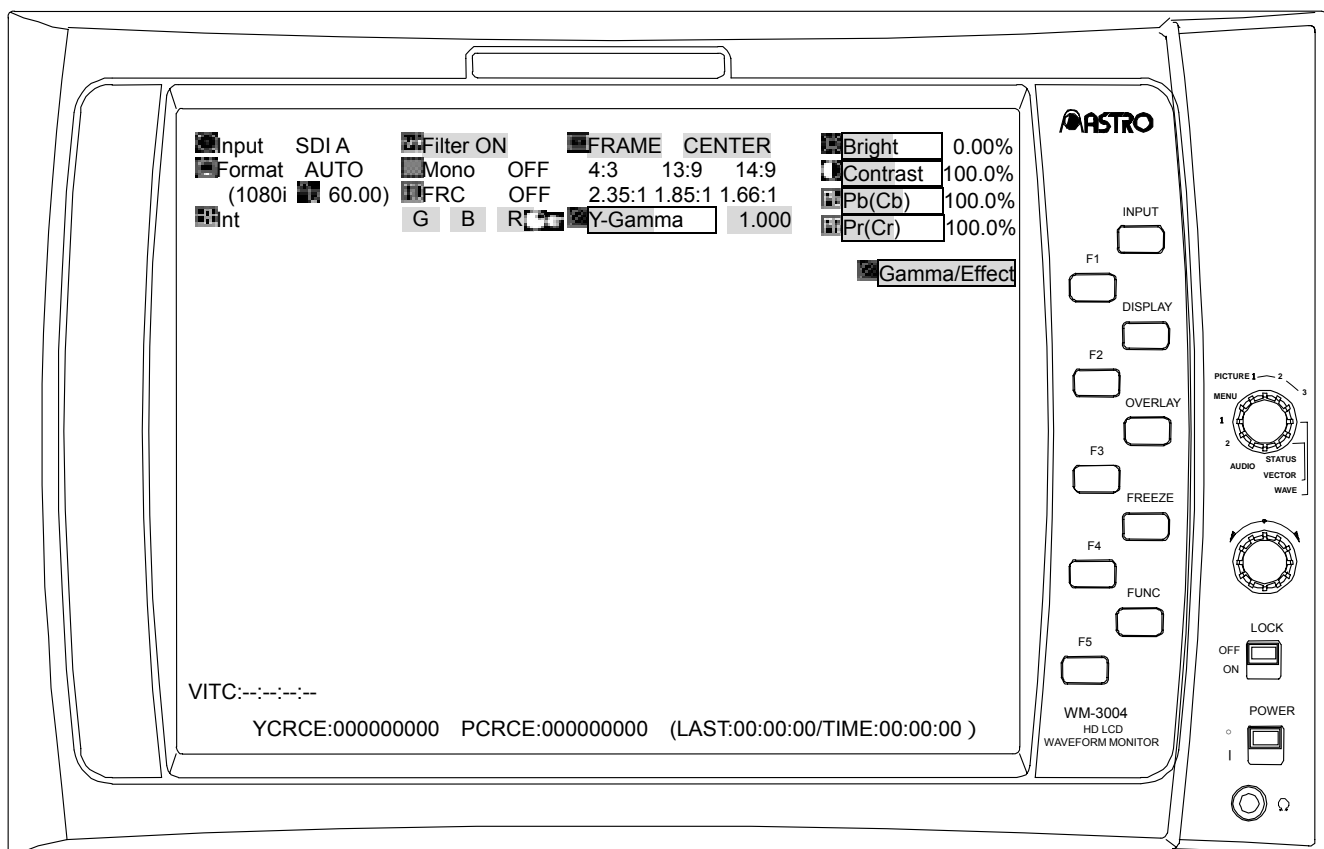

[Description of operations]

Switch	Description of function
FUNC switch	This switches the display to the picture adjustment 1 screen. (Refer to section 3.3.1.1)
F1 switch <input checked="" type="checkbox"/> Gamma/Effect	Press this to adjust the Y gamma value using the adjustment dial. Refer to section 4.5. (Variable range: 0.500-2.000; when 2.000 is exceeded, "Effect" is set.) When the setting switch is pressed, the Y gamma is restored to the initial value.
F2 switch	(Not used)
F3 switch	(Not used)
F4 switch	(Not used)
F5 switch	(Not used)

3.3.1.3 Color setting screen

<<Functions>>

When the OVERLAY switch is held down in the PICTURE1 mode, the input images can be displayed, and the following settings can be performed.

- Character color
- Marker color

<< screen >>

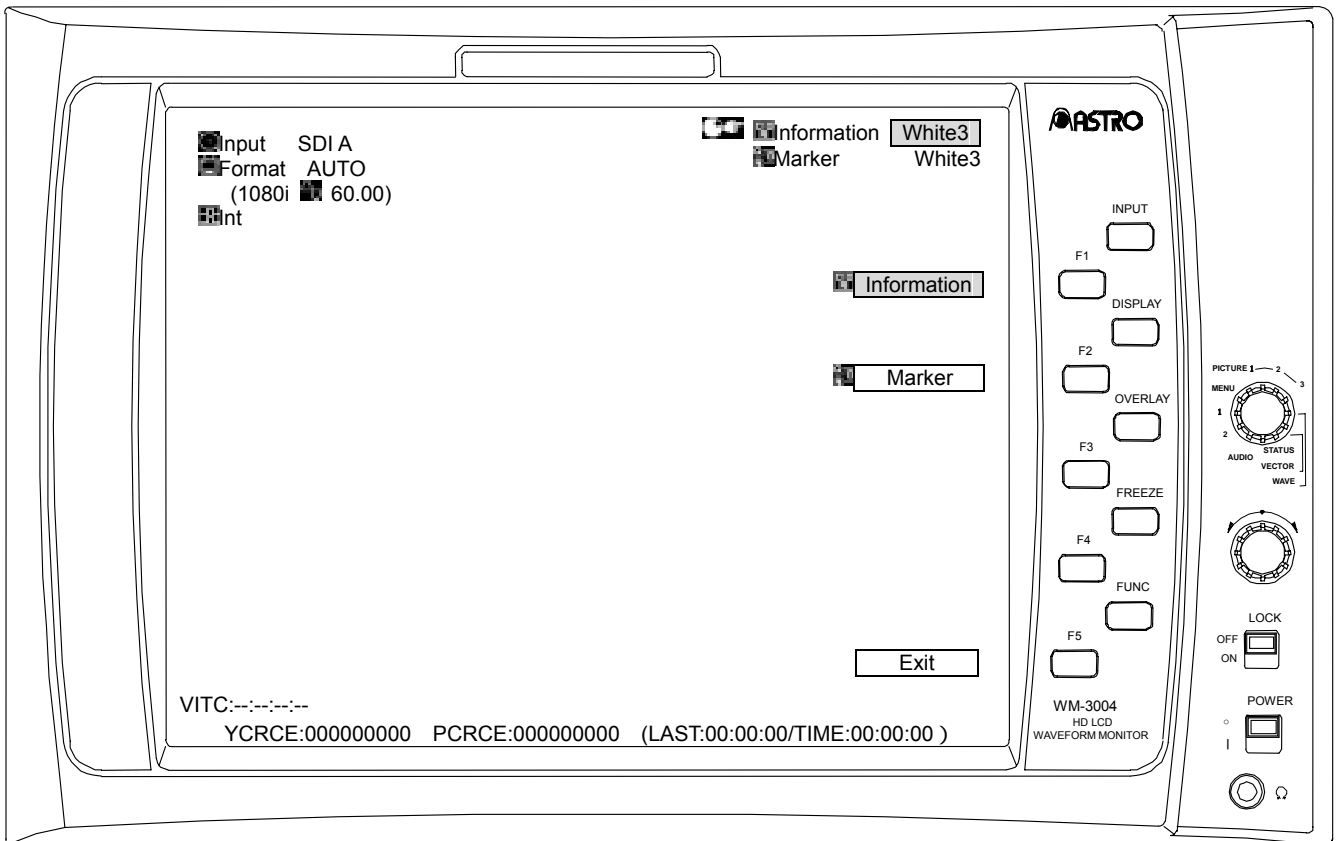

[Description of operations]

Switch	Description of function
FUNC switch	Press this to return the display to the previous screen.
F1 switch Information	Press this to select the color (any of 63 colors) of the characters using the adjustment dial. When the setting switch is pressed, the character color is restored to the initial value.
F2 switch Marker	Press this to select the color (any of 64 colors) of the markers using the adjustment dial. When the setting switch is pressed, the marker color is restored to the initial value.
F3 switch	(Not used)
F4 switch	(Not used)
F5 switch Exit	Press this to return the display to the previous screen.
OVERLAY switch	When this is held down, the display is returned to the previous screen.

3.3.2 PICTURE2 mode

3.3.2.1 Picture settings 1 screen

<<Functions>>

The input images can be displayed, and the following settings can be performed.

- Filter
- Monochrome
- FRC
- Markers

<<Screen>>

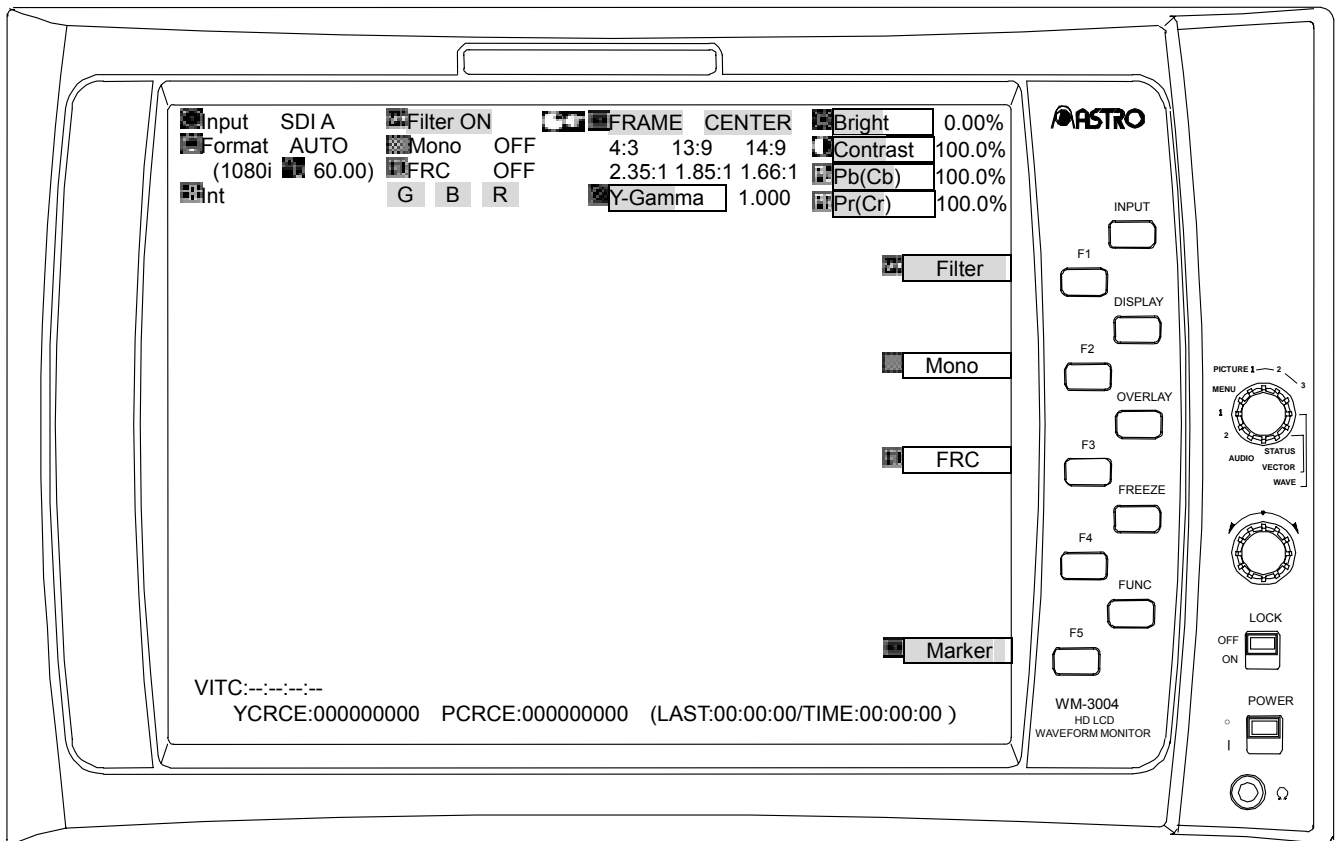

[Description of operations]

Switch	Description of function
FUNC switch	This switches the display to the picture settings 2 screen. (Refer to section 3.3.2.2)
F1 switch Filter	Press this to set the filter to ON or OFF.
F2 switch Mono	Press this to set monochrome to ON or OFF.
F3 switch FRC	Press this to set the 8-bit processing using frame rate control to ON or OFF.
F4 switch	(Not used)
F5 switch Marker	Press this to set the markers to ON or OFF. At the marker ON setting, select the markers using the adjustment dial and enter the selection using the setting switch

3.3.2.2 Picture settings 2 screen

<<Functions>>

The input images can be displayed, and the following settings can be performed.

- Selection of display or non-display for green, blue and red signals of the displayed pictures. (This affects only the picture display.)

<<Screen>>

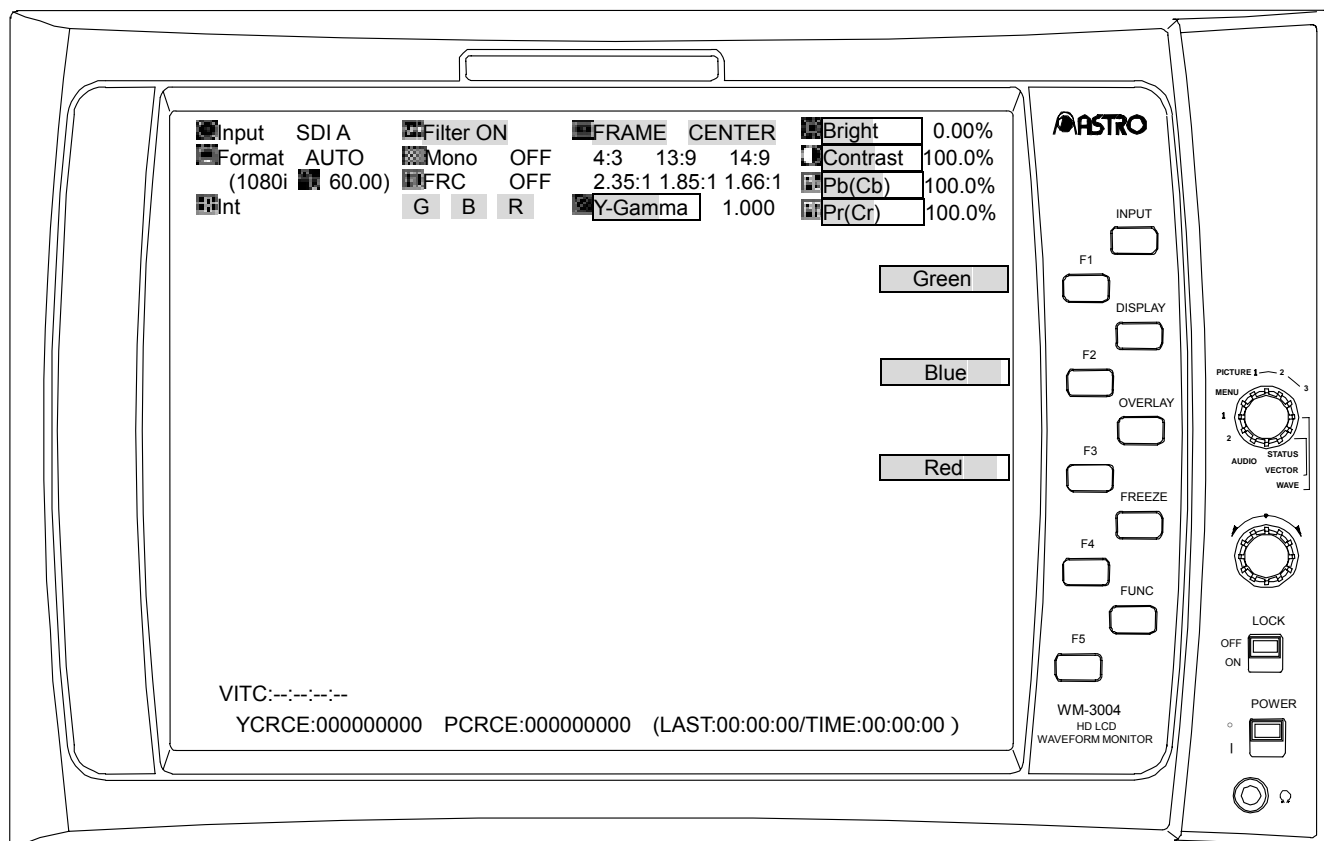

[Description of operations]

Switch	Description of function
FUNC switch	This switches the display to the picture settings 1 screen. (Refer to section 3.3.2.1)
F1 switch Green	Press this to select whether to display the green signals of the input pictures.
F2 switch Blue	Press this to select whether to display the blue signals of the input pictures.
F3 switch Red	Press this to select whether to display the red signals of the input pictures.
F4 switch	(Not used)
F5 switch	(Not used)

3.3.2.3 Color setting screen

<<Functions>>

When the OVERLAY switch is held down in the PICTURE2 mode, the input pictures can be displayed, and the following settings can be performed.

- Character color
- Marker color

<<screen>>

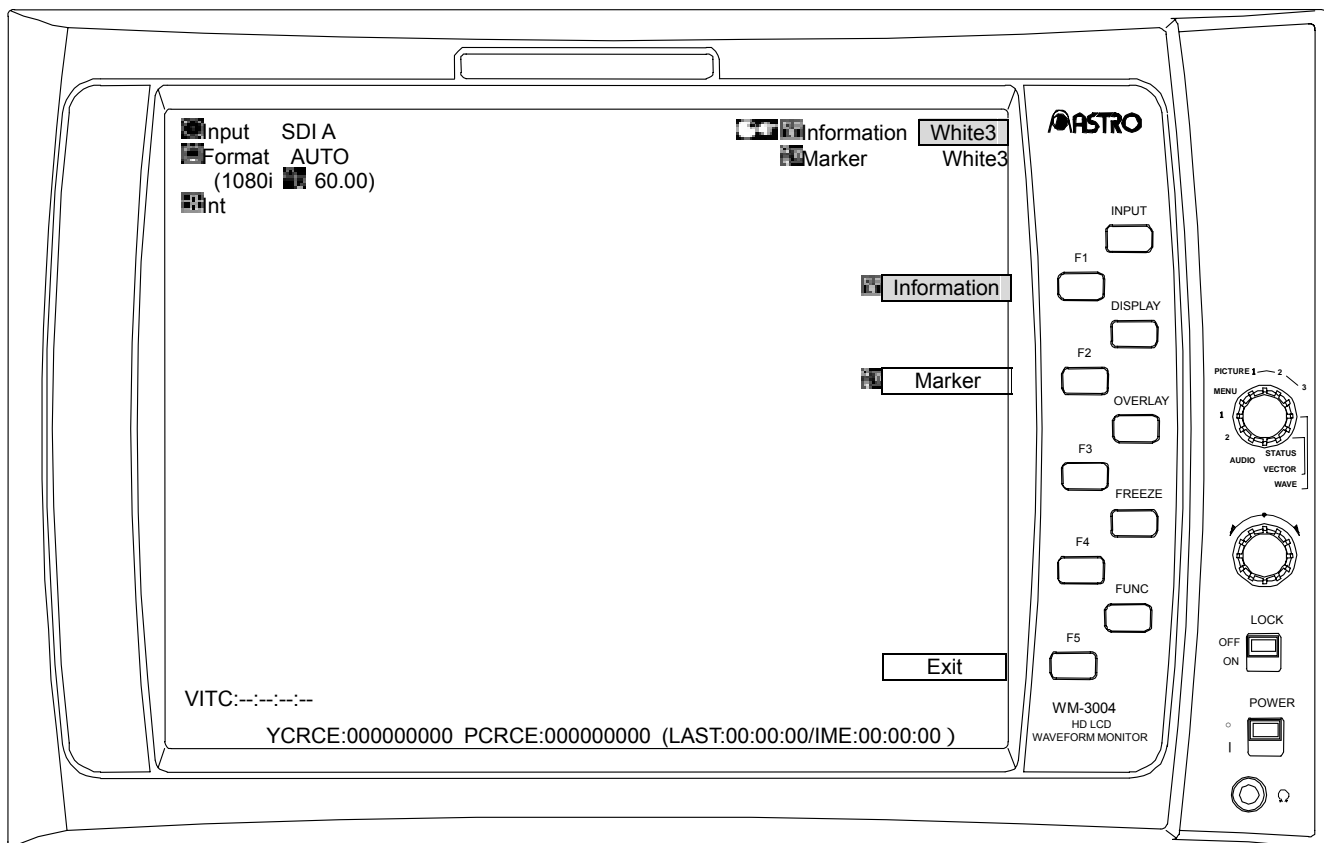

[Description of operations]

Switch	Description of function
FUNC switch	Press this to return the display to the previous screen.
F1 switch Information	Press this to select the color (any of 63 colors) of the characters using the adjustment dial. When the setting switch is pressed, the character color is restored to the initial value.
F2 switch Marker	Press this to select the color (any of 64 colors) of the markers using the adjustment dial. When the setting switch is pressed, the marker color is restored to the initial value.
F3 switch	(Not used)
F4 switch	(Not used)
F5 switch Exit	Press this to return the display to the previous screen.
OVERLAY switch	When this is held down, the display is returned to the previous screen.

3.3.3 PICTURE3 mode

3.3.3.1 Regular screen

<<Functions>>

The input pictures are displayed, and all displays with the exception of NoSignal, the time code (VITC), Freeze and the markers are cleared. Apart from displaying the time code (VITC), the functions in the PICTURE3 mode are identical to the PICTURE2 mode functions.

<<Screen>>

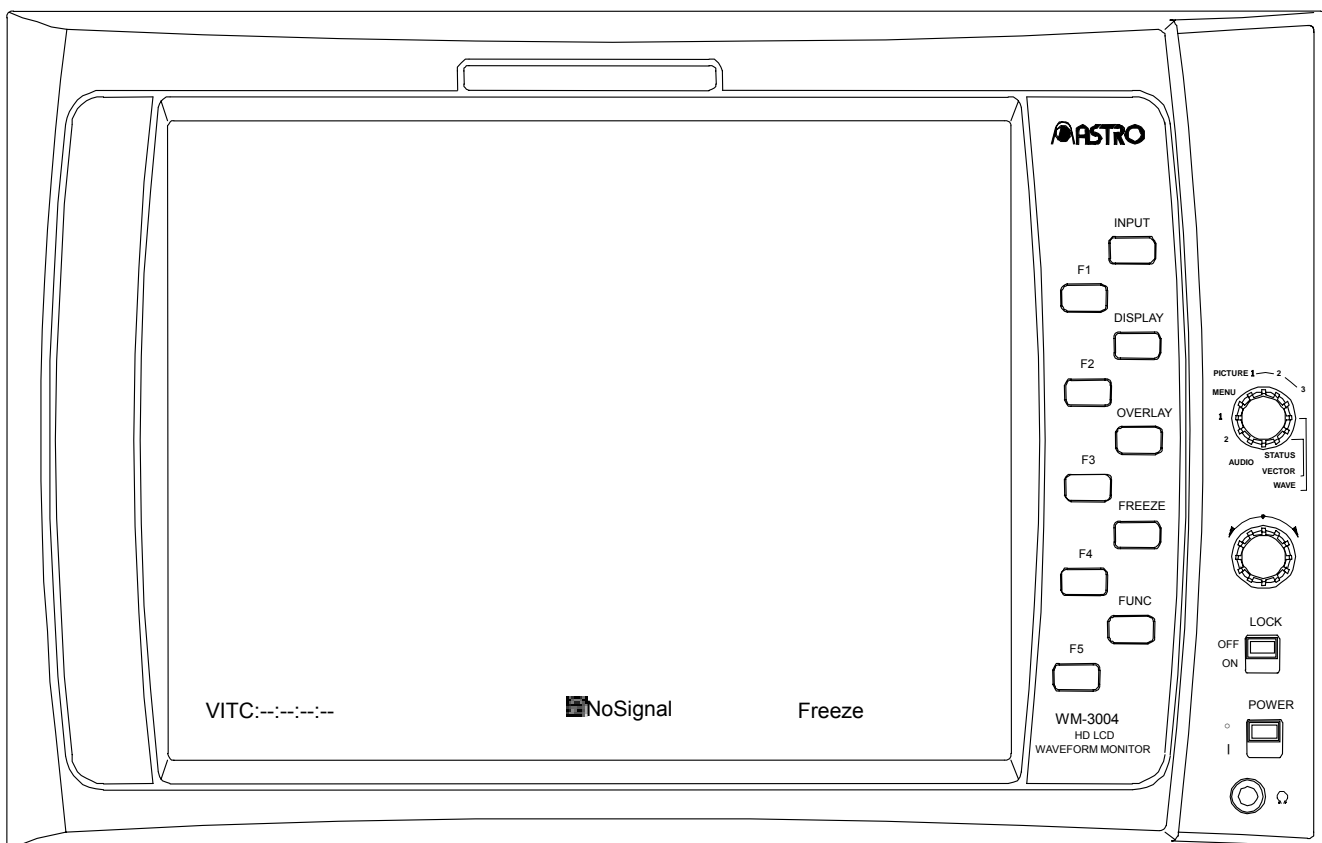

[Description of operations]

Switch	Description of function
FUNC switch	(Not used)
Adjustment dial	(Not used)
Setting switch	(Not used)
F1 switch	(Not used)
F2 switch	(Not used)
F3 switch	(Not used)
F4 switch	(Not used)
F5 switch	(Not used)

3.3.3.2 Color setting screen

<<Functions>>

When the OVERLAY switch is held down in the PICTURE3 mode, the input pictures can be displayed, and the following settings can be performed.

- Character color
- Marker color

<<screen>>

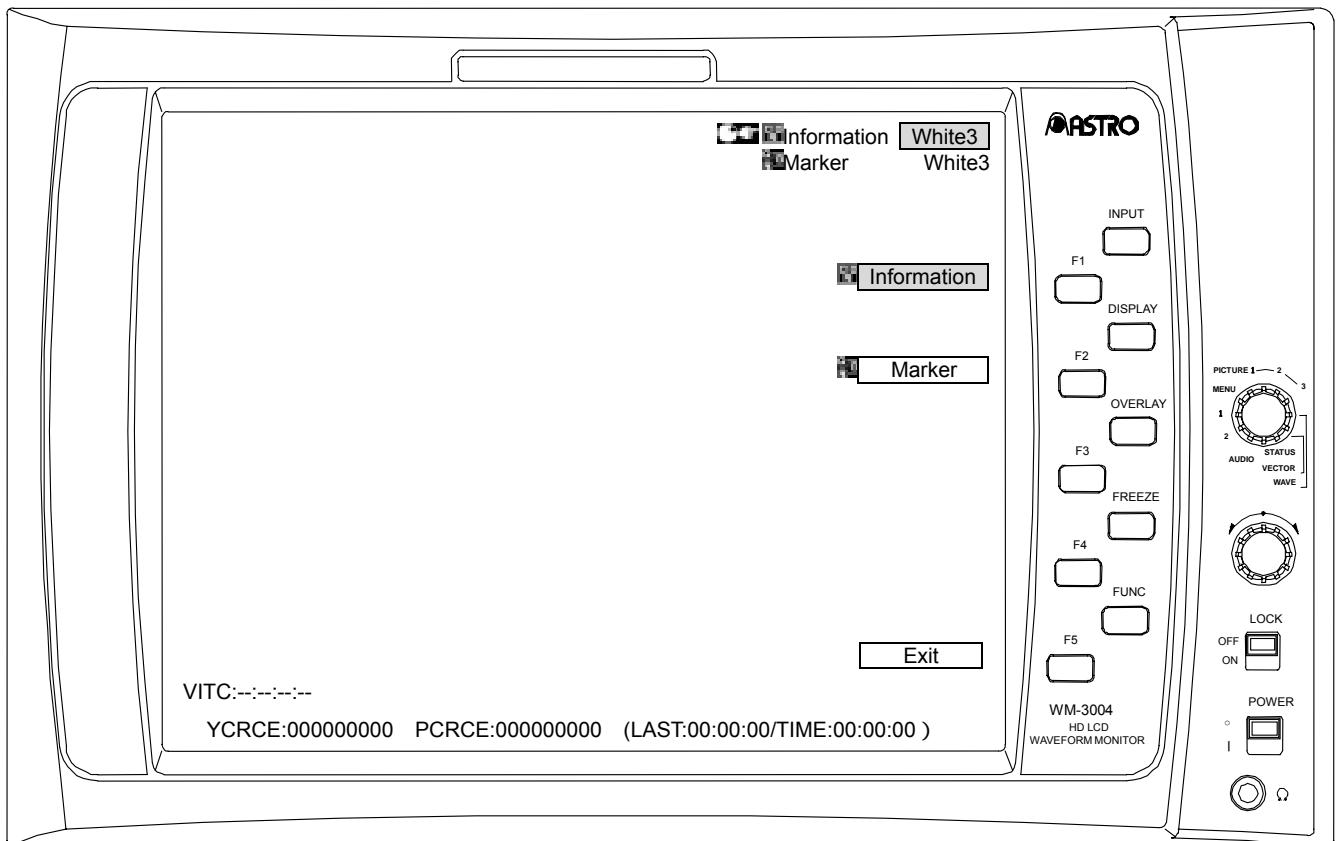

[Description of operations]

Switch	Description of function
FUNC switch	Press this to return the display to the normal screen. (Refer to section 3.3.3.1)
F1 switch 	Press this to select the color (any of 63 colors) of the characters using the adjustment dial. When the setting switch is pressed, the character color is restored to the initial value.
F2 switch 	Press this to select the color (any of 64 colors) of the markers using the adjustment dial. When the setting switch is pressed, the marker color is restored to the initial value.
F3 switch	(Not used)
F4 switch	(Not used)
F5 switch 	Press this to return the display to the normal screen. (Refer to section 3.3.3.1)
OVERLAY switch	When this is held down, the display is returned to the normal screen. (Refer to section 3.3.3.1)

3.3.4 WAVEFORM mode

3.3.4.1 Function screen

<<Functions>>

The waveforms are displayed on this screen.

<<Screen>>

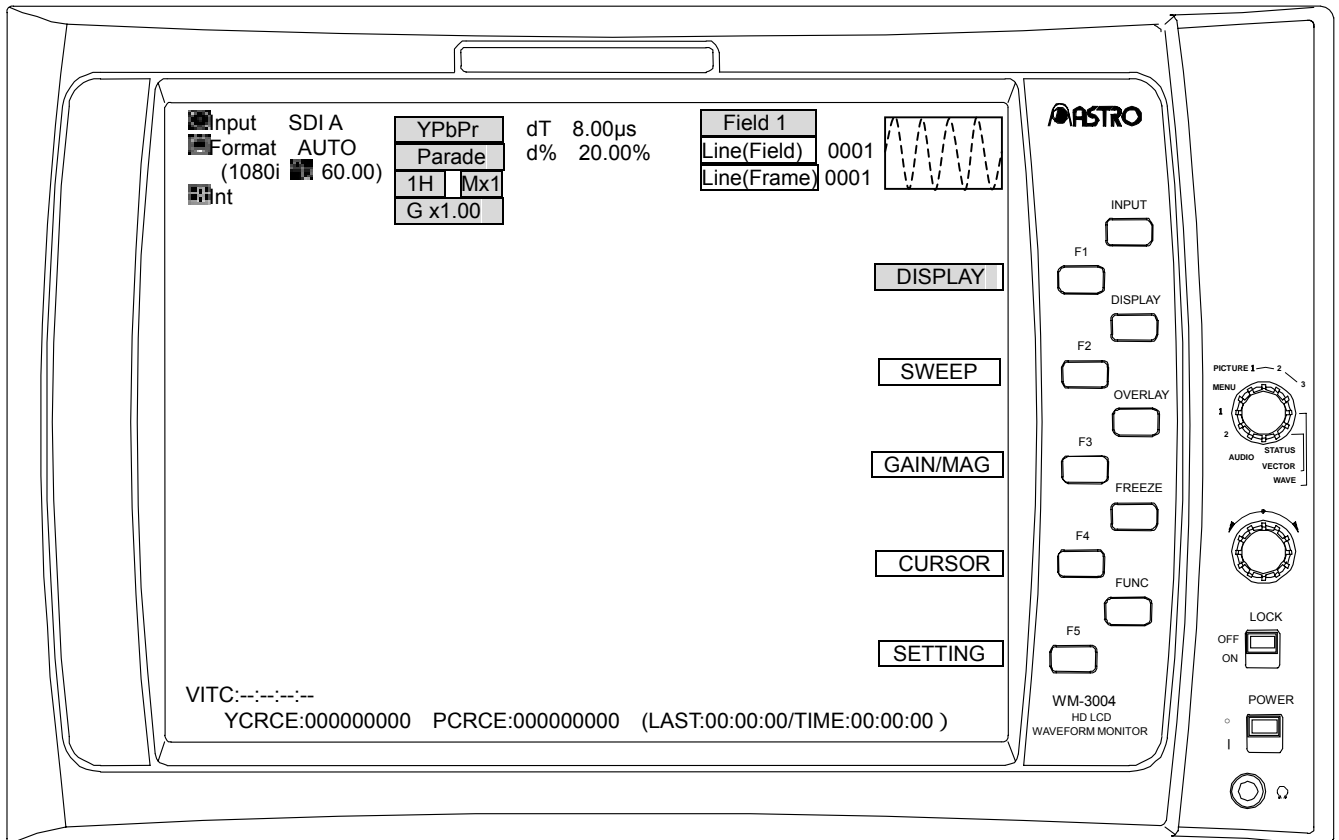

[Description of operations]

Switch	Description of function
FUNC switch	Press this to return the display to the previous screen.
Adjustment dial	(Not used)
Setting switch	(Not used)
F1 switch DISPLAY	Press this to set the display to the DISPLAY setting screen. (Refer to section 3.3.4.2)
F2 switch SWEEP	Press this to set the display to the SWEEP setting screen. (Refer to section 3.3.4.3)
F3 switch GAIN/MAG	Press this to set the display to the GAIN/MA setting screen. (Refer to section 3.3.4.4)
F4 switch CURSOR	Press this to set the display to the CURSOR setting screen. (Refer to section 3.3.4.5)
F5 switch SETTING	Press this to set the display to the WAVEFORM mode setting screen. (Refer to section 3.3.4.6)

3.3.4.2 DISPLAY setting screen

<<Functions>>

The waveforms can be displayed, and the following settings can be performed.

- Switching between parade display (side-by-side display) and overlay display (superimposed display) for the waveforms
- Line select function (with 1H, 2H)

<<Screen>>

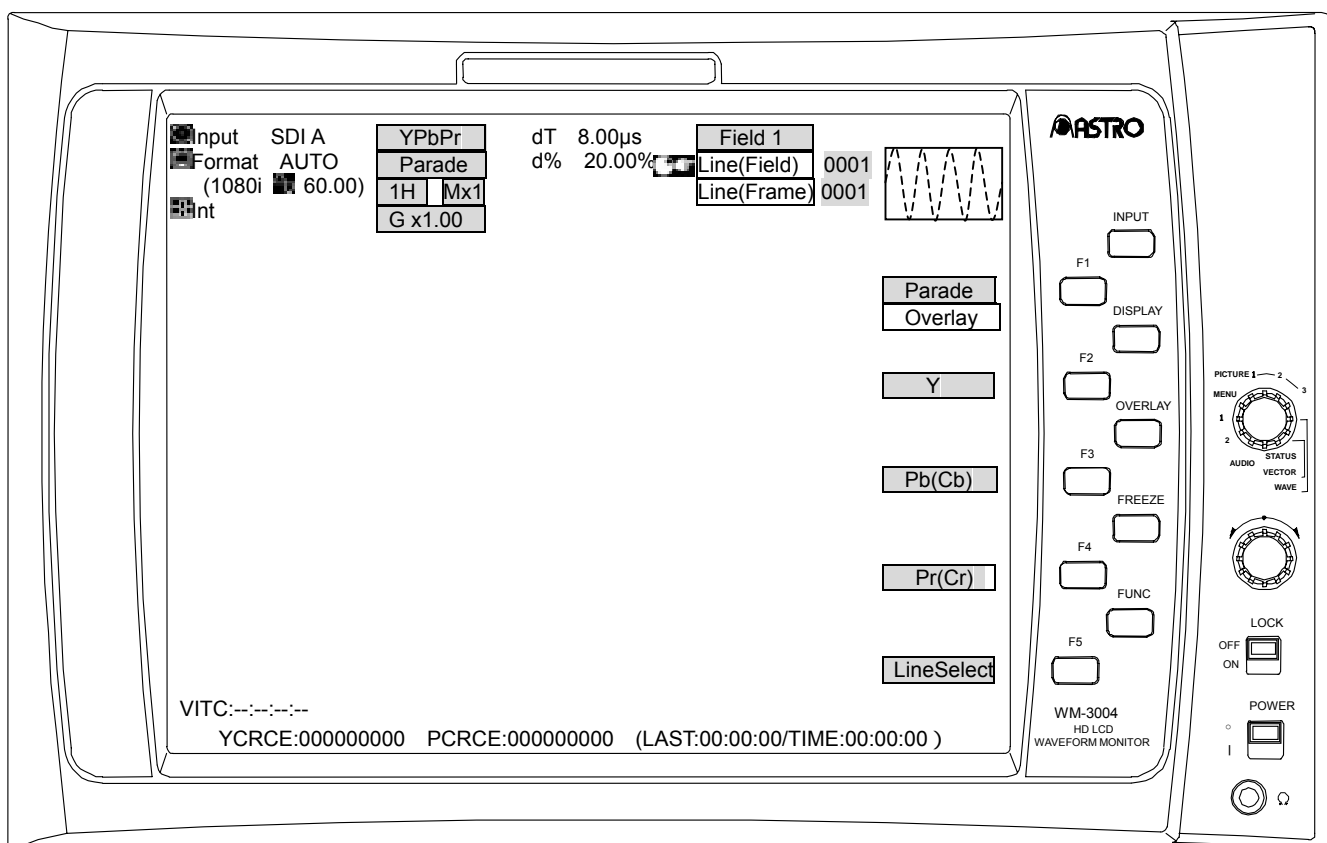

[Description of operations]

Switch	Description of function
FUNC switch	Press this to return the display to the function screen. (Refer to section 3.3.4.1)
F1 switch Parade/Overlay	Press this to switch between parade display (side-by-side display) and overlay display (superimposed display) for the waveforms.
F2 switch Y	Press this to set Y/G to ON or OFF.
F3 switch Pb(Cb)	Press this to set Pb/B to ON or OFF.
F4 switch Pr(Cr)	Press this to set Pr/R to ON or OFF.
F5 switch LineSelect	Press this to set line select to ON or OFF. When line select is ON, the lines are incremented or decremented using the adjustment dial, and the field is switched using the setting switch. (This applies with 1H or 2H only; field switching applies only with interlacing or segmented frame format.)

3.3.4.3 SWEEP setting screen

<<Functions>>

The waveforms can be displayed, and the following settings can be performed.

- 1H, 2H, 1F or 2F display switching
- Line select function (with 1H or 2H)

<<Screen>>

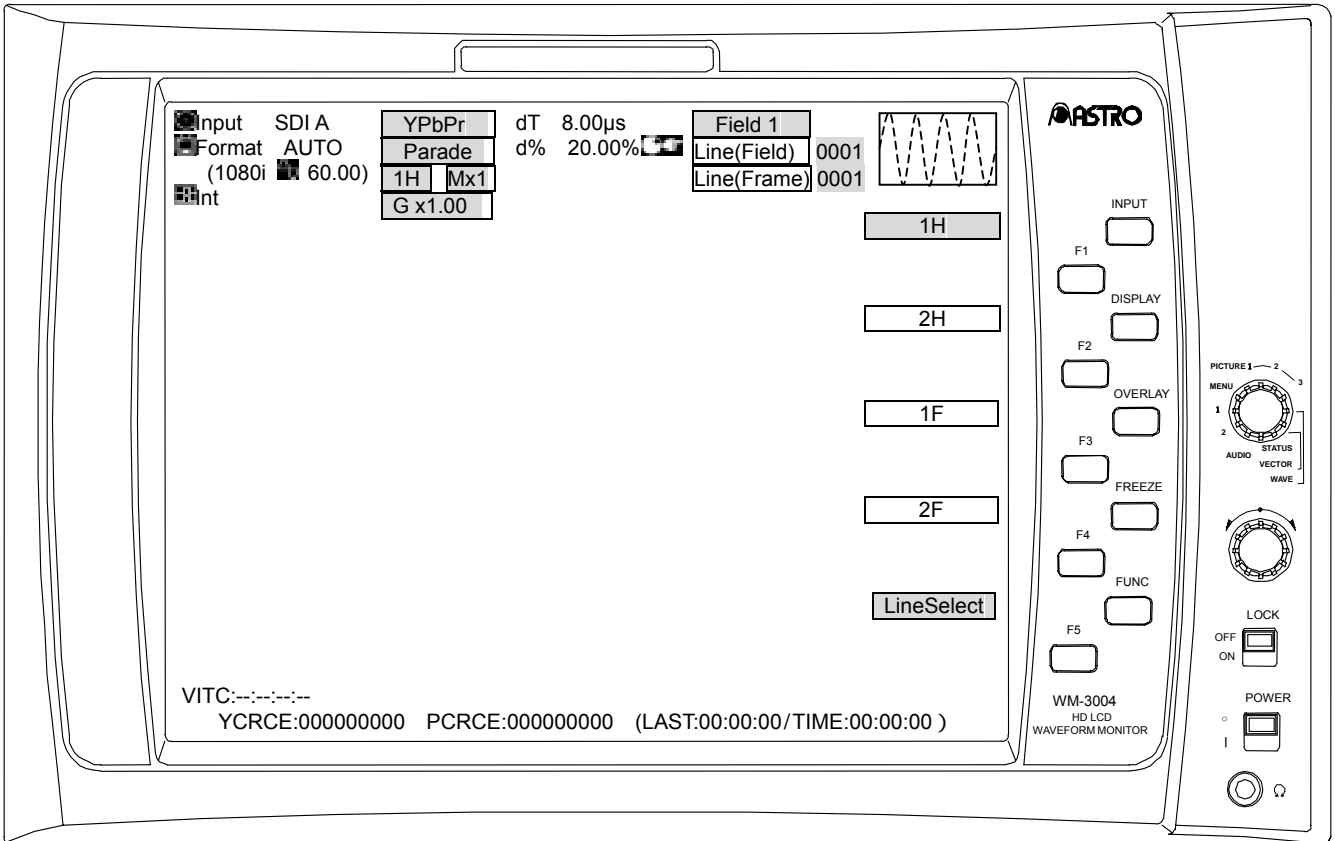

[Description of operations]

Switch	Description of function
FUNC switch	Press this to return the display to the function screen. (Refer to section 3.3.4.1)
F1 switch 1H	1H
F2 switch 2H	2H (with interlacing or segmented frame format) In the line select OFF status, the odd-numbered fields are displayed on the left side, and the even-numbered fields are displayed on the right side. In the line select ON status, the selected line is displayed on the left side, and the next line in the selected field is displayed on the right side.
F3 switch 1F	1F The horizontal blanking data is not displayed.
F4 switch 2F	2F (with interlacing or segmented frame format) The odd-numbered fields are displayed on the left side, and the even-numbered fields are displayed on the right side. The horizontal blanking data is not displayed.
F5 switch LineSelect	Press this to set line selection to ON or OFF. In the line select ON status, the lines are incremented or decremented using the adjustment dial, and the field is switched using the setting switch. (This applies with 1H or 2H only; field switching applies only with interlacing or segmented frame format.)

3.3.4.4 GAIN/MAG setting screen

<<Functions>>

The waveforms can be displayed, and the following settings can be performed.

- Gain (0.03X to 7.97X), MAG (1X, 2X or 4X) setting
- Scroll functions

<<Screen>>

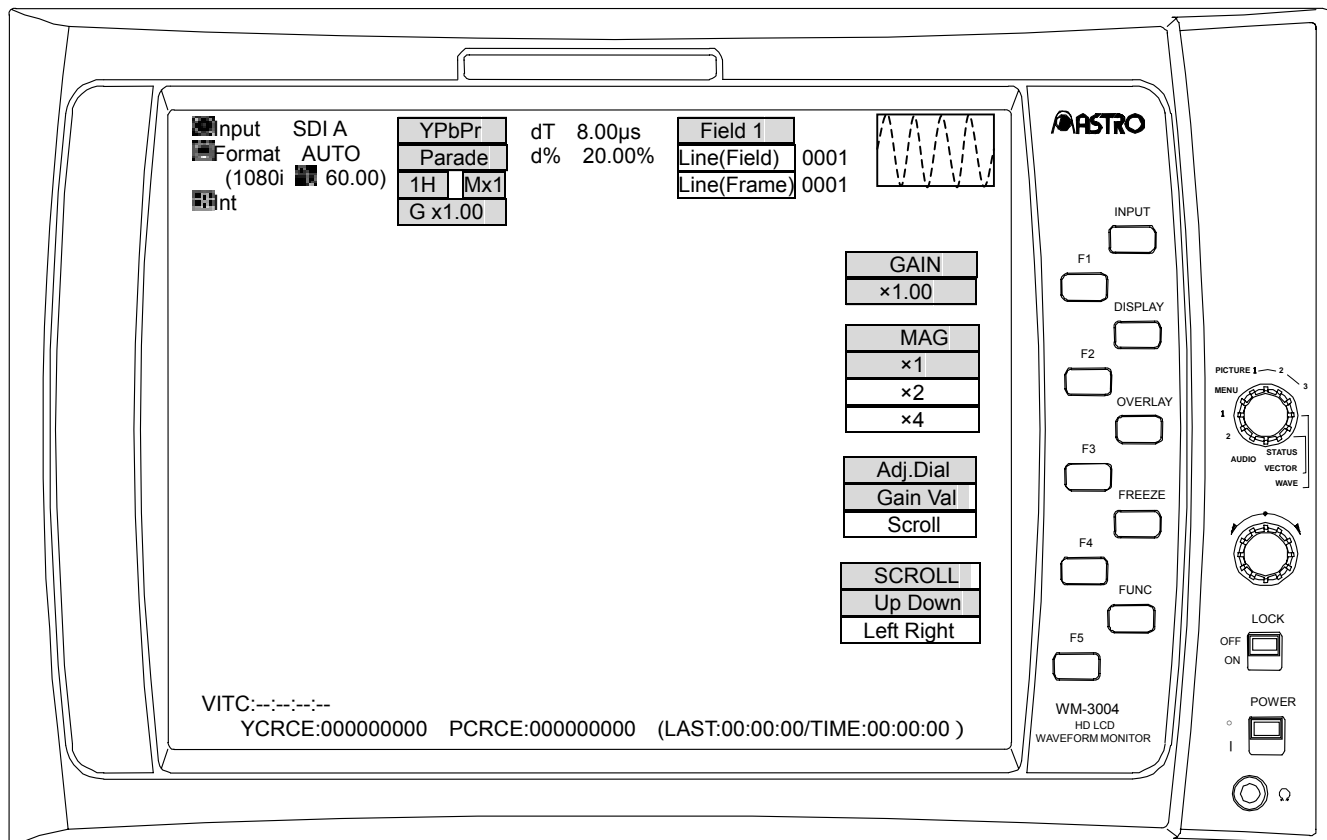

[Description of operations]

Switch	Description of function	
FUNC switch	Press this to return the display to the function screen. (Refer to section 3.3.4.1)	
Adjustment dial	When setting the gain GainVal	Use the dial to set the magnification rate of the gain. (Variable range: 0.03 to 7.97)
	When scrolling Scroll	Use the dial to scroll vertically or horizontally.
Setting switch	When setting the gain GainVal	The gain is an integral value after the decimal places have been rounded down (with a figure of 4 or below) or rounded up (with a figure of 5 or above). (All values below 1.00 are set to 1.00; similarly, all values above 7.00 are set to 7.00.) If the gain magnification rate is an integer, it is increased in 1.00 increments, and when 7.00 is reached, it is returned to 1.00.)
	When scrolling Scroll	Use the switch to reset the scrolling.
F1 switch GAIN x*. **	Press this to switch the adjustment dial and setting switch functions to gain.	
F2 switch MAG x1/x2/x4	Press this to select the MAG magnification rate (1X, 2X or 4X).	
F3 switch RENC GainVal/Scroll	Press this to switch the adjustment dial function between the gain setting and scrolling.	
F4 switch UP DOWN/LEFT RIGHT	Press this to select vertical (up/down) or horizontal (left/right) scrolling.	
F5 switch	(Not used)	

3.3.4.5 CURSOR setting screen

<<Functions>>

The waveforms can be displayed, and the following setting can be performed.

- H and V cursor display and difference display (mV, μ s)

<<Screen>>

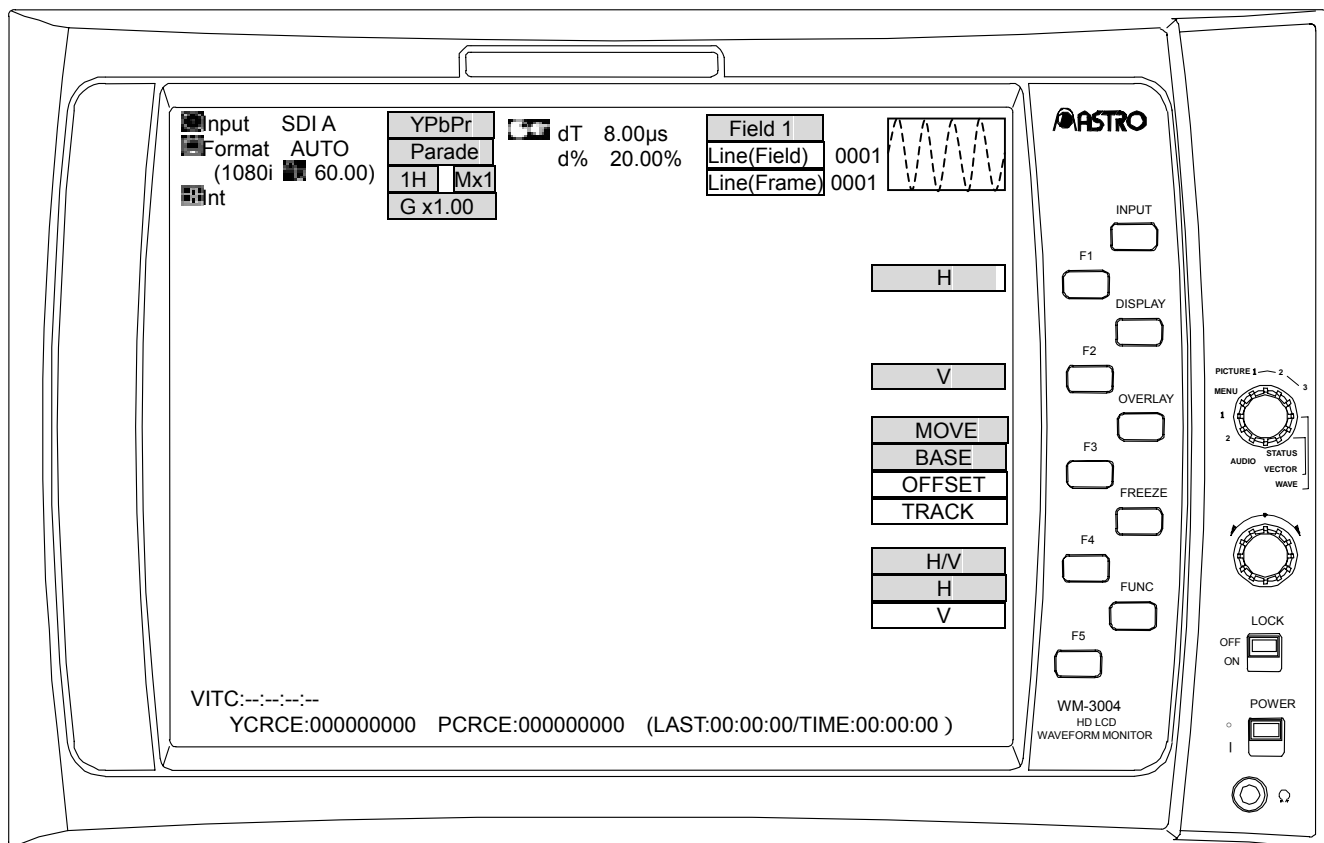

[Description of operations]

Switch	Description of function
FUNC switch	Press this to return the display to the function screen. (Refer to section 3.3.4.1)
Adjustment dial	Use this to move the cursor horizontally or vertically.
Setting switch	(Not used)
F1 switch H	Press this to set the H cursor to ON or OFF.
F2 switch V	Press this to set the V cursor to ON or OFF.
F3 switch MOVE BASE/OFFSET/TRACK	Press this to select the cursor (BASE, OFFSET or TRACK) to be moved.
F4 switch H/V	Press this to select the cursor (H or V) to be moved.
F5 switch	(Not used)

3.3.4.6 WAVEFORM setting screen

<<Functions>>

The waveforms can be displayed, and the following settings can be performed.

- Waveform display YPbPr/GBR switching
- V ancillary (Wave), H blanking switching
- Scale switching
- LPF (Wave) switching

<<Screen>>

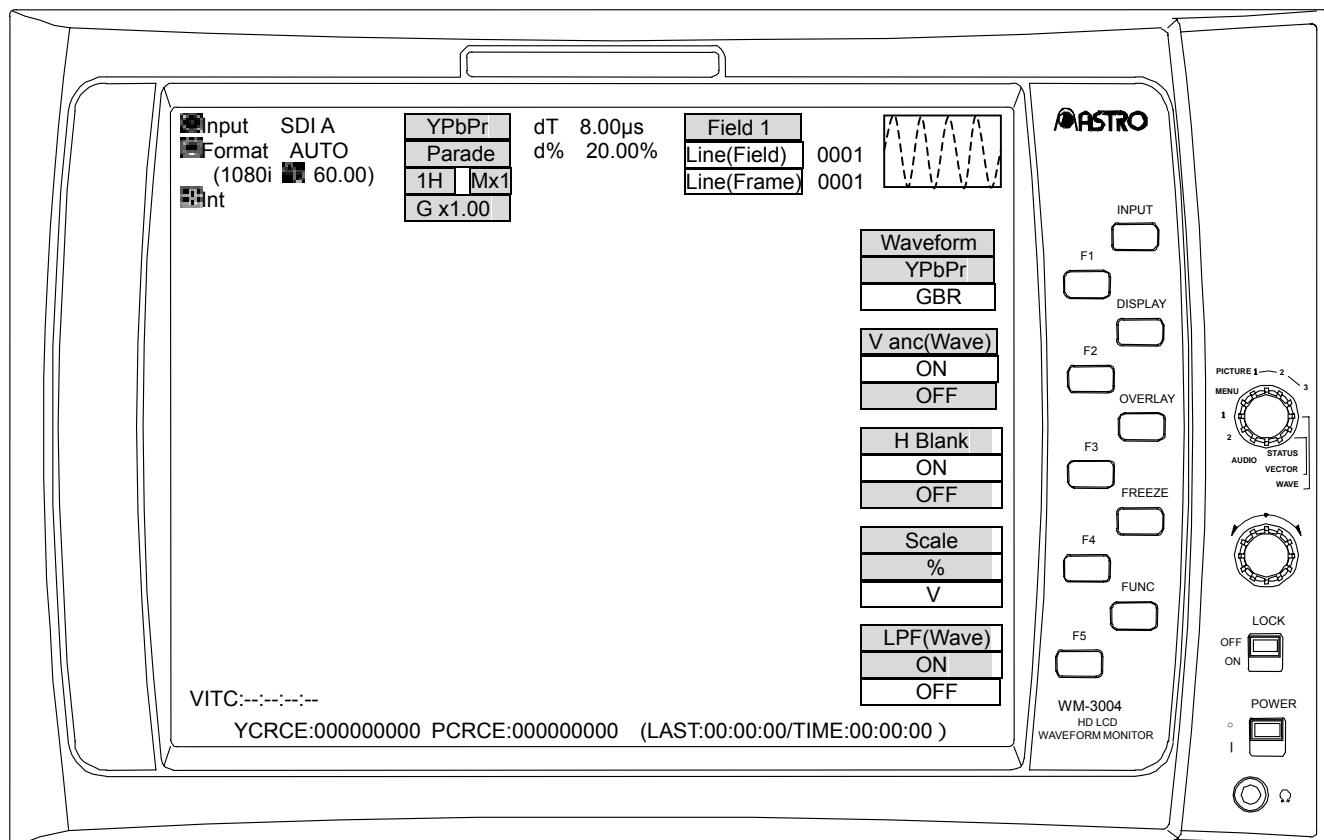

[Description of operations]

Switch	Description of function
FUNC switch	Press this to return the display to the function screen. (Refer to section 3.3.4.1)
Adjustment dial	(Not used)
Setting switch	(Not used)
F1 switch Waveform YPbPr/GBR	Press this to switch between YPbPr and GBR for the waveform display.
F2 switch V anc ON/OFF	Press this to set V ancillary to ON or OFF. This takes effect only when the WAVEFORM mode is established.
F3 switch H Blank ON/OFF	Press this to set H blanking to ON or OFF.
F4 switch Scale %/V	Press this to switch the scale units between % and V.
F5 switch LPF(Wave) ON/OFF	Press this to set the low-pass filter (Wave) to ON or OFF. This takes effect only when the WAVEFORM mode is established.

3.3.4.7 Color setting screen

<<Functions>>

When the OVERLAY switch is held down in the WAVEFORM mode, the following settings can be performed.

- Character color
- Scale color
- Waveform color and brightness
- Cursor color

<<Screen>>

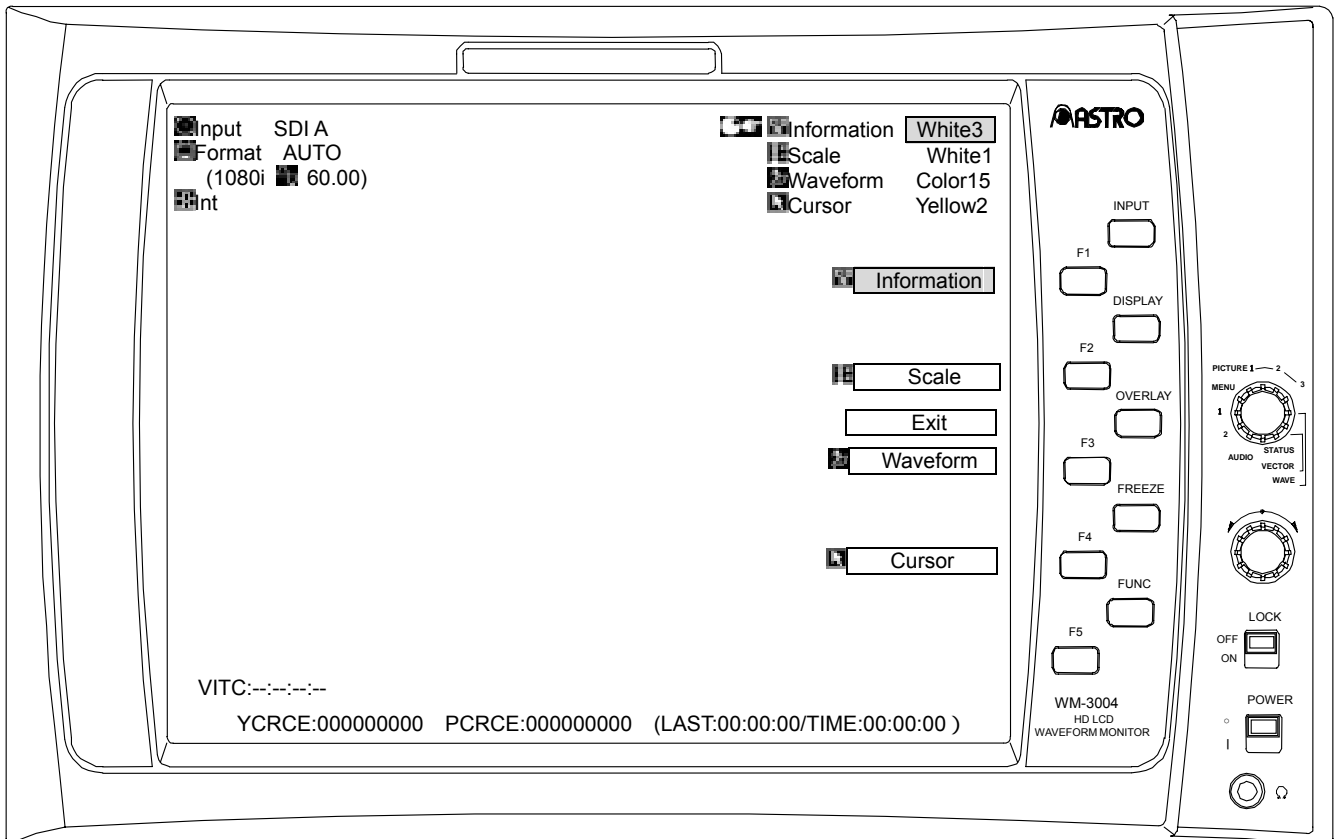

[Description of operations]

Switch	Description of function
FUNC switch	Press this to return the display to the previous screen.
F1 switch Information	Press this to select the color (any of 63 colors) of the characters using the adjustment dial. When the setting switch is pressed, the character color is restored to the initial value.
F2 switch Scale	Press this to select the color (any of 64 colors) of the scale using the adjustment dial. When the setting switch is pressed, the scale color is restored to the initial value.
F3 switch Waveform	Press this to select the color (any of 62 colors) and brightness of the waveforms using the adjustment dial. When the setting switch is pressed, the waveform color is restored to the initial value.
F4 switch Cursor	Press this to select the color (any of 64 colors) of the cursor using the adjustment dial. When the setting switch is pressed, the cursor color is restored to the initial value.
F5 switch Exit	Press this to return the display to the previous screen.
OVERLAY switch	When this is held down, the display is returned to the previous screen.

3.3.5 VECTOR mode

3.3.5.1 Normal screen

<<Functions>>

The signals on the vectorscope can be displayed, and the following settings can be performed.

- Increase of black, white levels
- Line selection function

<<Screen>>

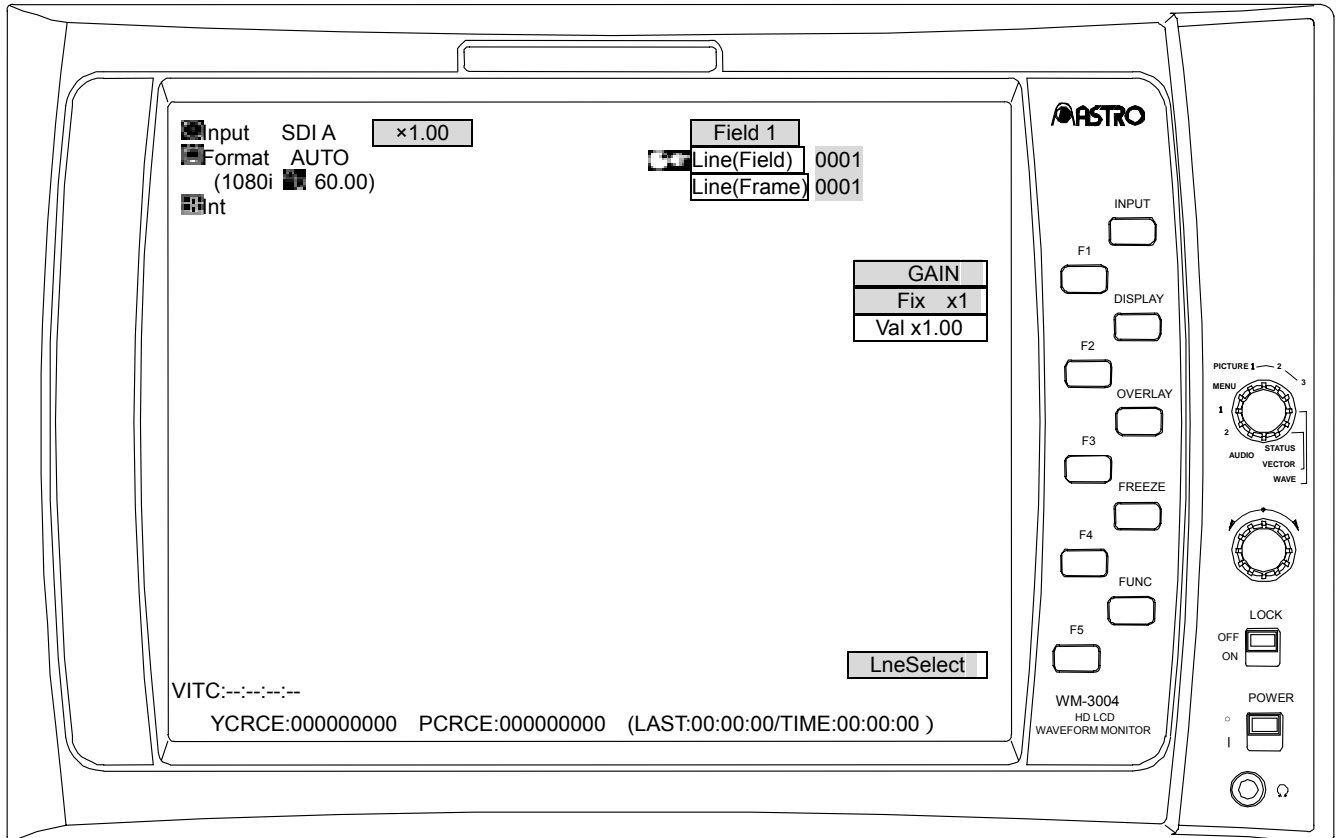

[Description of operations]

Switch	Description of function	
FUNC switch	This switches the display to the VECTOR mode setting screen. (Refer to section 3.3.5.2)	
Adjustment dial	When the gain setting is fixed <input type="checkbox"/> Fix x1	(Not used)
	When the gain setting can be varied <input type="checkbox"/> Val x*. **	Use the dial to set the magnification rate of the gain. (Variable range: 0.03 to 7.97)
	When line select is ON	Use the dial to increment or decrement the lines.
Setting switch	When the gain setting is fixed <input type="checkbox"/> Fix x1	(Not used)
	When the gain setting can be varied <input type="checkbox"/> Val x*. **	The gain is an integral value after the decimal places have been rounded down (with a figure of 4 or below) or rounded up (with a figure of 5 or above). (All values below 1.00 are set to 1.00; similarly, all values above 7.00 are set to 7.00.) If the gain magnification rate is an integer, it is increased in 1.00 increments, and when 7.00 is reached, it is returned to 1.00.)
	When line select is ON	Use the switch to select the field. (This applies with 1H or 2H only; field switching applies only with interlacing or segmented frame format.)
F1 switch <input type="checkbox"/> GAIN Fix x1/Val x*. **	Press this switch to set line select to OFF and switch between the fixed (Fix x1) and variable (x*. **) gain setting. In the fixed (Fix x1) status, the loci between the pixels are interpolated for the display; in the variable status, only the points are displayed.	
F2 switch	(Not used)	
F3 switch	(Not used)	
F4 switch	(Not used)	
F5 switch <input type="checkbox"/> LineSelect	Press this to set line select to ON or OFF. When line select is ON, the gain setting is fixed (Fix x1).	

3.3.5.2 VECTOR mode setting screen

<<Functions>>

The signals on the vectorscope can be displayed, and the following settings can be performed.

- V ancillary (Vect) switching
- Scale switching
- LPF (Vect) switching

<<Screen>>

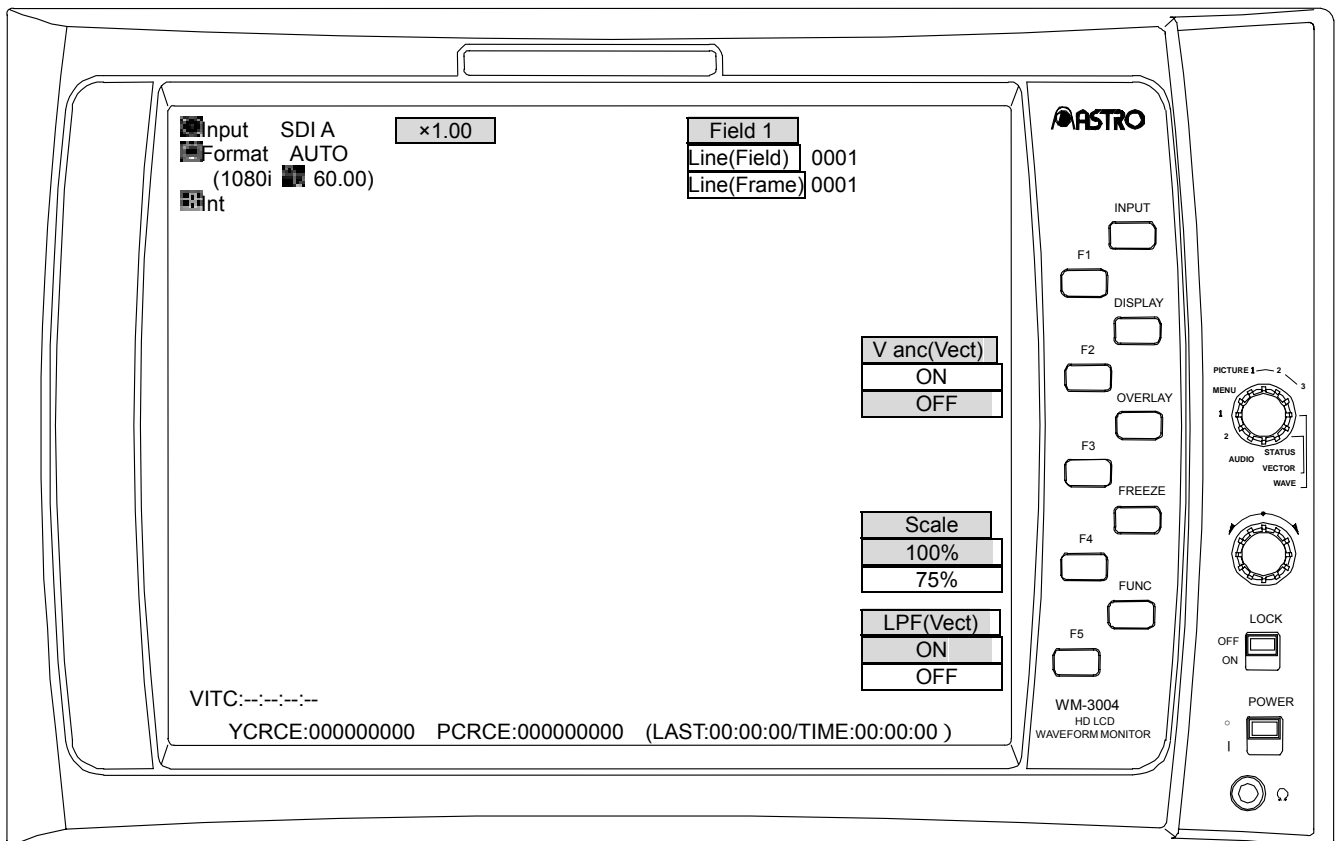

[Description of operations]

Switch	Description of function
FUNC switch	This switches the display to the normal screen. (Refer to section 3.3.5.1)
Adjustment dial	(Not used)
Setting switch	(Not used)
F1 switch	(Not used)
F2 switch V anc(Vect) ON/OFF	Press this to set V ancillary to ON or OFF. This takes effect only when the VECTOR mode is established.
F3 switch	(Not used)
F4 switch Scale 100%/75%	Press this to switch the scale between 100% or 75%.
F5 switch LPF(Wave) ON/OFF	Press this to set the low-pass filter (Vect) to ON or OFF. This takes effect only when the VECTOR mode is established.

3.3.5.3 Color setting screen

<<Functions>>

When the OVERLAY switch is held down in the VECTOR mode, the following settings can be performed.

- Character color
- Scale color
- Vector color and brightness
- Cursor color

<<Screen>>

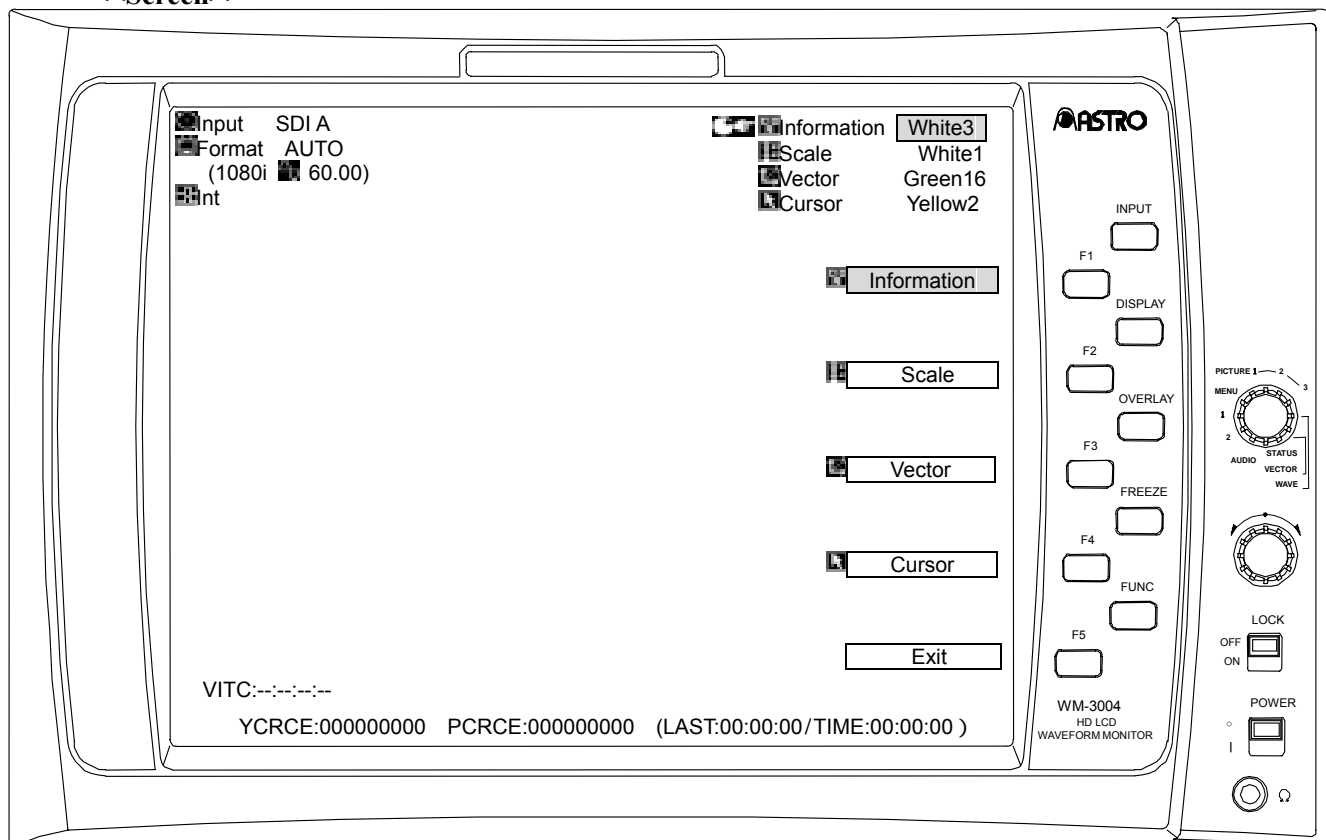

[Description of operations]

Switch	Description of function
FUNC switch	Press this to return the display to the previous screen.
F1 switch Information	Press this to select the color (any of 63 colors) of the characters using the adjustment dial. When the setting switch is pressed, the character color is restored to the initial value.
F2 switch Scale	Press this to select the color (any of 64 colors) of the scale using the adjustment dial. When the setting switch is pressed, the scale color is restored to the initial value.
F3 switch Vector	Press this to select the color (any of 64 colors) and brightness of the vectors using the adjustment dial. When the setting switch is pressed, the vector color is restored to the initial value.
F4 switch Cursor	Press this to select the color (any of 64 colors) of the cursor using the adjustment dial. When the setting switch is pressed, the cursor color is restored to the initial value.
F5 switch Exit	Press this to return the display to the previous screen.
OVERLAY switch	When this is held down, the display is returned to the previous screen.

3.3.6 STATUS mode

3.3.6.1 Normal screen

<<Functions>>

The statuses can be displayed, and the following settings can be performed.

- Status (numerical value) display
- EAV, SAV display

<<Screen>>

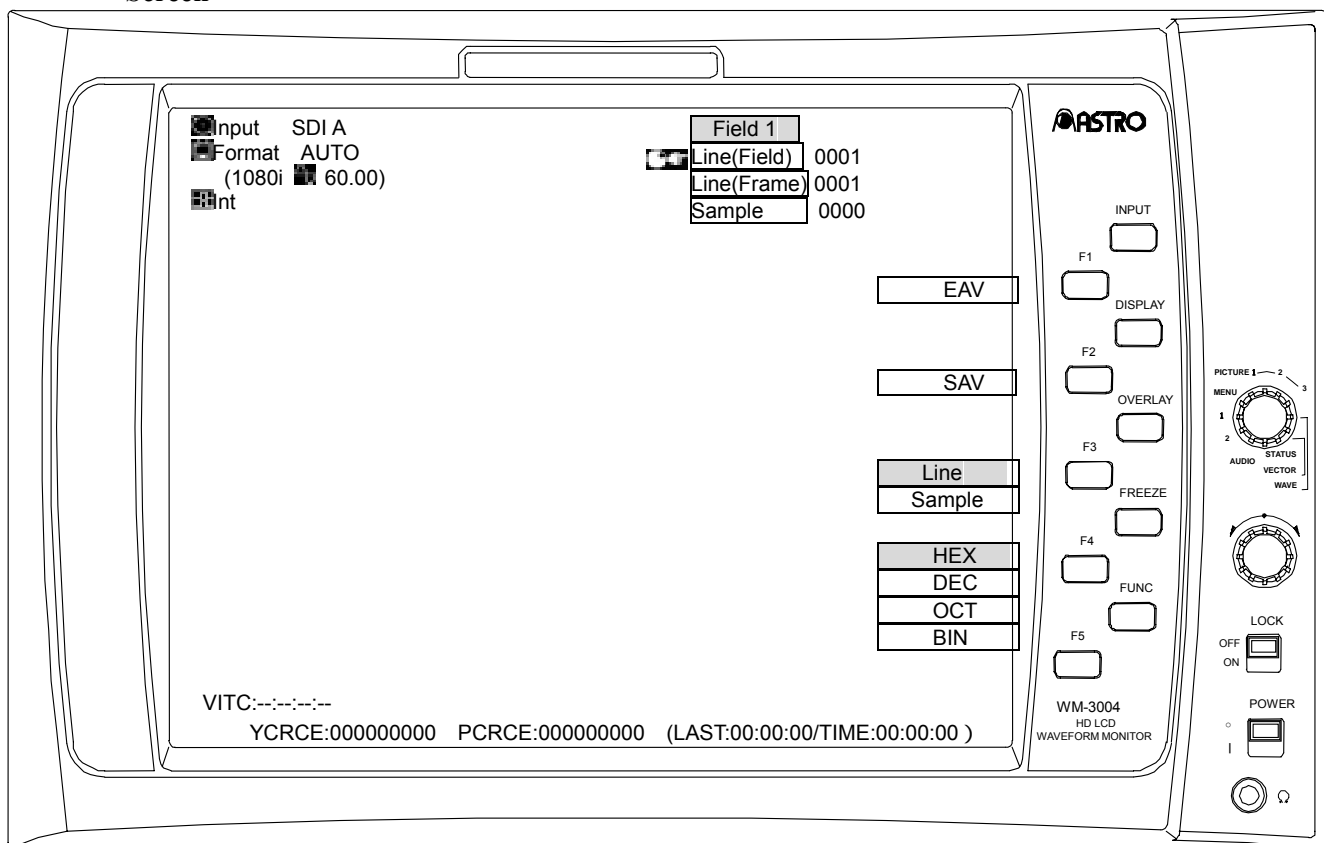

[Description of operations]

Switch	Description of function
FUNC switch	(Not used)
Adjustment dial	Use the dial to increment or decrement the lines or samples in the status displayed.
Setting switch	Press this to select the field (with interlacing or segmented frame format).
F1 switch EAV	Press this to jump to EAV.
F2 switch SAV	Press this to jump to SAV.
F3 switch Line/Sample	Press this to select the item (Line or Sample) to be set using the adjustment dial.
F4 switch HEX/DEC/OCT/BIN	Press this to select HEX (hexadecimal), DEC (decimal), OCT (octal) or BIN (binary) for the cardinal numbers of the displayed data.
F5 switch	(Not used)

3.3.6.2 Color setting screen

<<Functions>>

When the OVERLAY switch is held down in the STATUS mode, the following settings can be performed.

- Character color
- Scale color
- Status color
- Cursor color

<<Screen>>

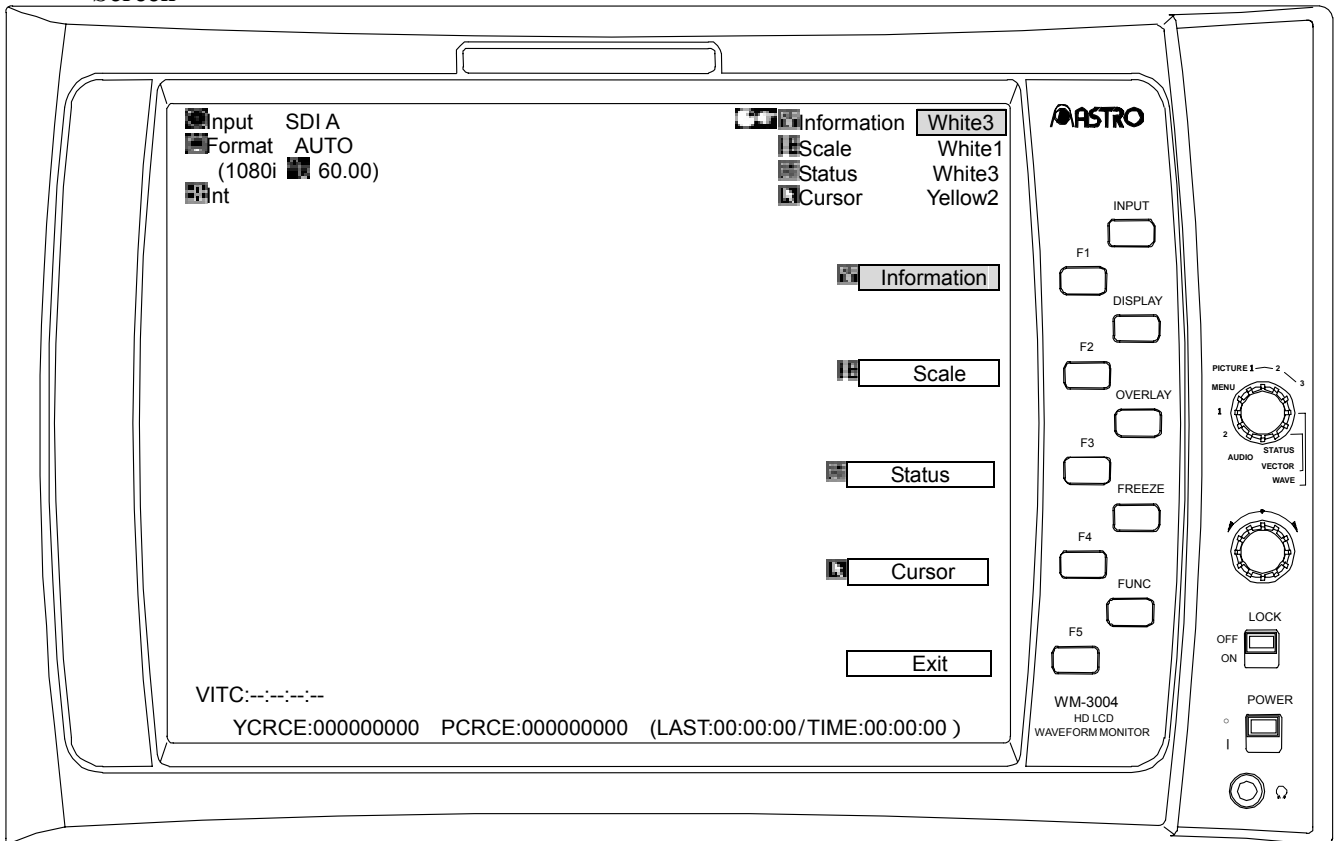

[Description of operations]

Switch	Description of function
FUNC switch	Press this to return the display to the previous screen.
F1 switch Information	Press this to select the color (any of 63 colors) of the characters using the adjustment dial. When the setting switch is pressed, the character color is restored to the initial value.
F2 switch Scale	Press this to select the color (any of 64 colors) of the scale using the adjustment dial. When the setting switch is pressed, the scale color is restored to the initial value.
F3 switch Status	Press this to select the color (any of 64 colors) of the statuses using the adjustment dial. When the setting switch is pressed, the status color is restored to the initial value.
F4 switch Cursor	Press this to select the color (any of 64 colors) of the cursor using the adjustment dial. When the setting switch is pressed, the cursor color is restored to the initial value.
F5 switch Exit	Press this to return the display to the previous screen.
OVERLAY switch	When this is held down, the display is returned to the previous screen.

3.3.7 AUDIO mode

3.3.7.1 Normal screen

<<Functions>>

The audio level meter is displayed, and the following function is provided.

- Audio monitor display

<<Screen>>

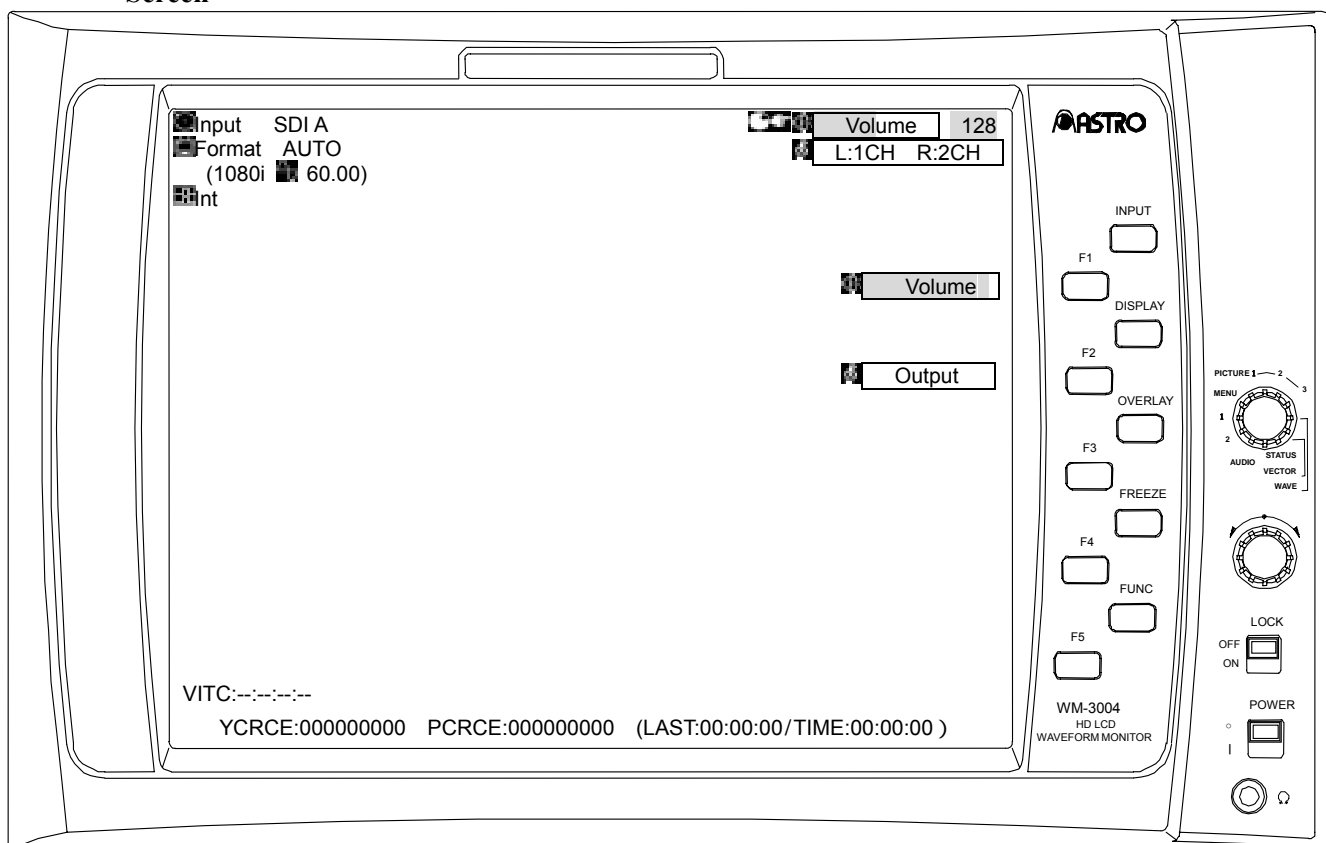

[Description of operations]

Switch	Description of function
FUNC switch	(Not used)
F1 switch Volume	Press this to adjust the volume level using the adjustment dial. (Variable range: 0-255) When the setting switch is pressed, the volume level is restored to the initial value.
F2 switch Output	Press the F2 switch, and use the adjustment dial to set the embedded audio channels through which the sound is to be output. When the setting switch is pressed, the output channel settings are restored to the initial values.
F3 switch	(Not used)
F4 switch	(Not used)
F5 switch	(Not used)

3.3.7.2 Color setting screen

<<Functions>>

When the OVERLAY switch is held down in the AUDIO mode, the following settings can be performed.

- Character color
- Scale color
- Status color

<<Screen>>

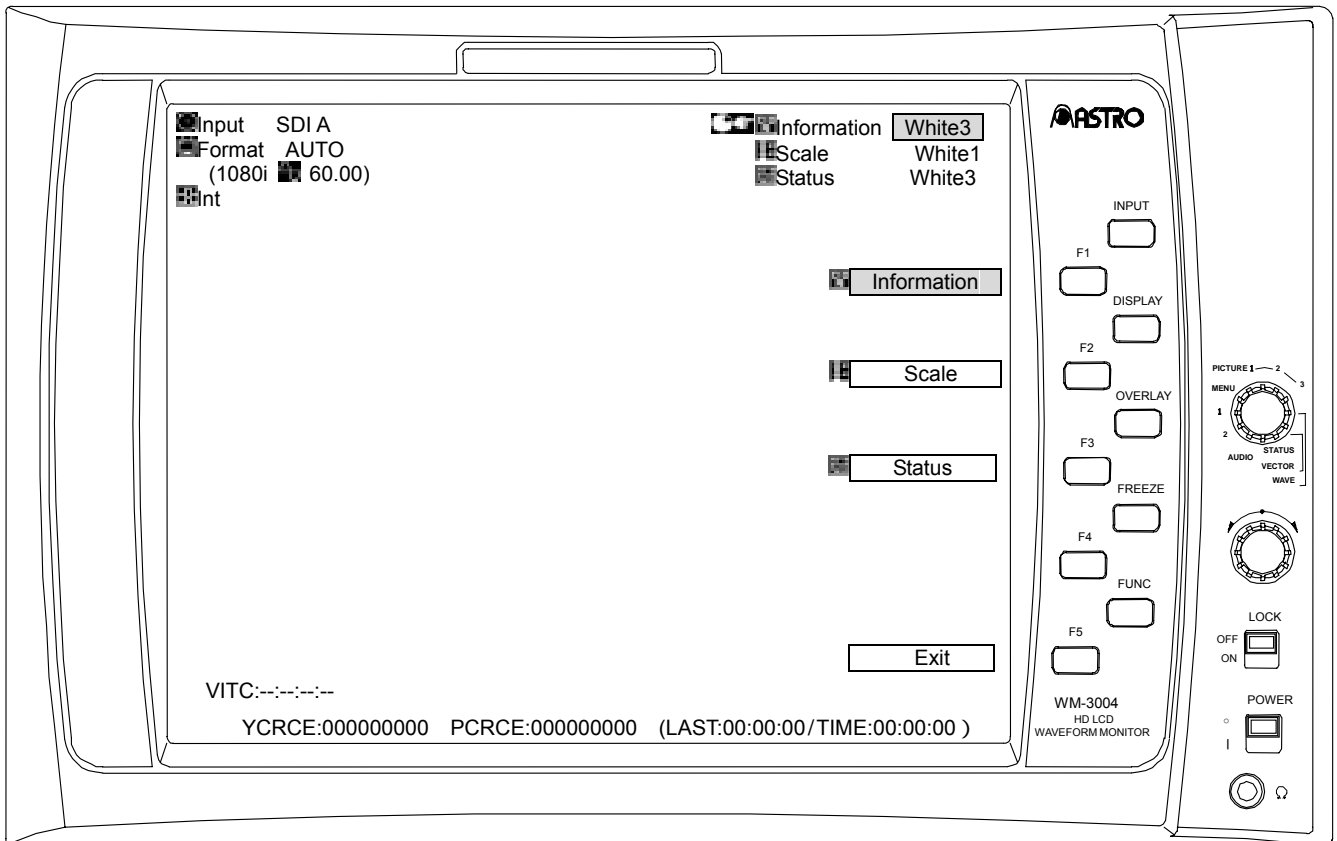

[Description of operations]

Switch	Description of function
FUNC switch	Press this to return the display to the normal screen. (Refer to section 3.3.7.1)
F1 switch 	Press this to select the color (any of 63 colors) of the characters using the adjustment dial. When the setting switch is pressed, the character color is restored to the initial value.
F2 switch 	Press this to select the color (any of 64 colors) of the scale using the adjustment dial. When the setting switch is pressed, the scale color is restored to the initial value.
F3 switch 	Press this to select the color (any of 64 colors) of the statuses using the adjustment dial. When the setting switch is pressed, the status color is restored to the initial value.
F4 switch	(Not used)
F5 switch 	Press this is to return the display to the normal screen. (Refer to section 3.3.7.1)
OVERLAY switch	When this is held down, the display is returned to the normal screen. (Refer to section 3.3.7.1)

3.3.8 MENU mode

3.3.8.1 Normal screen

<<Functions>>



The menu screens can be displayed, and the following settings can be performed.

- Format selection
- Reference setting
- Icon animation setting
- Error count resetting
- Initializing

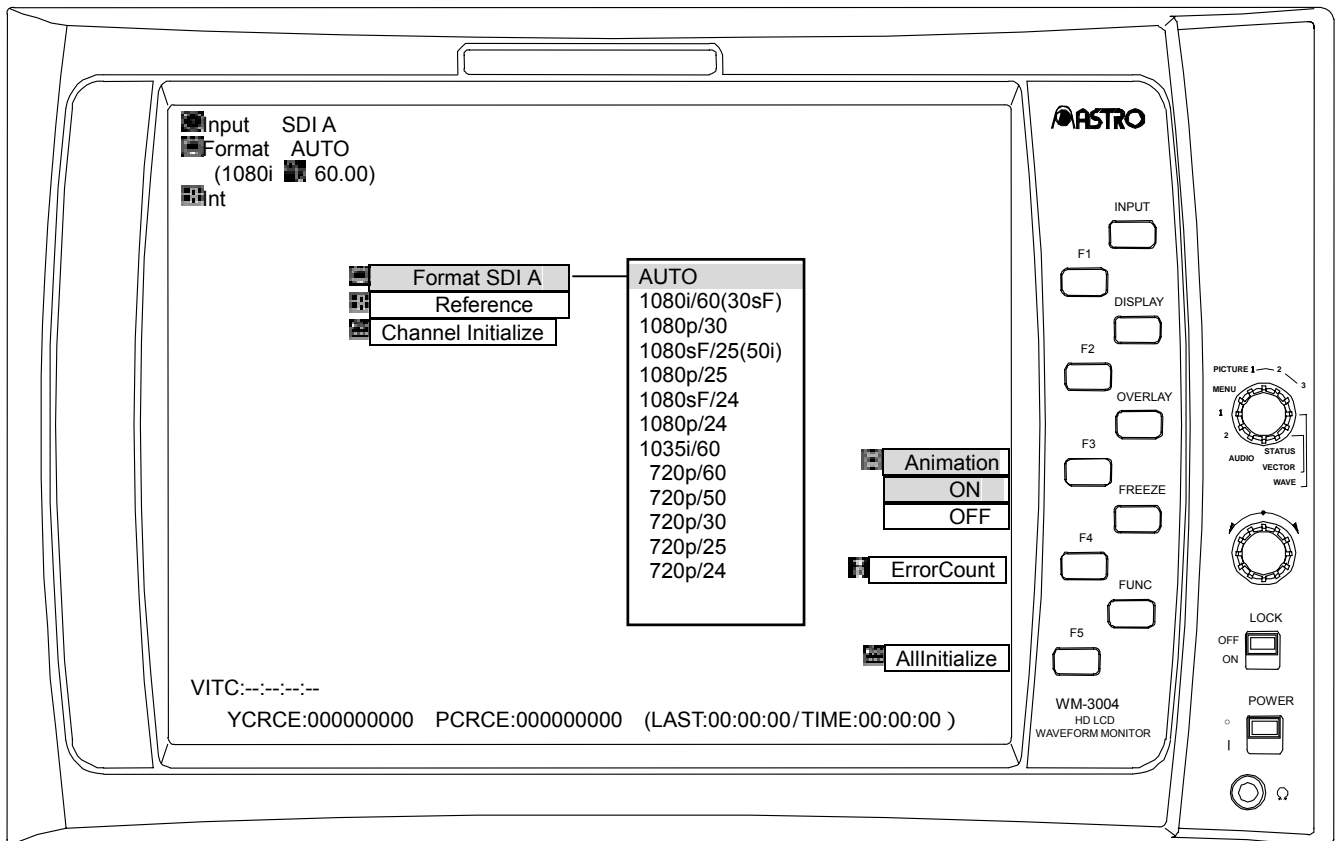
<<Screen>>



[Description of operations]

Switch	Description of function
FUNC switch	(Not used)
Adjustment dial	Use the dial to select the items to be set.
Setting switch	Press this to select the format, set the reference or initialize the setting of the currently selected channel (reset to the CRC error count). Refer to section 4.6. If the freeze status is established when the format is selected, it is released.
F1 switch	(Not used)
F2 switch	(Not used)
F3 switch  Animation	Press this to set the icon animation to ON or OFF.
F4 switch  ErrorCount	Press this to reset the CRC error count and elapsed time.
F5 switch  AllInitialize	When this is held down, the settings of all the channels are initialized, and the CRC error count is reset. Refer to section 4.6.

3.3.8.2 Color setting screen

<<Functions>>

When the OVERLAY switch is held down in the MENU mode, the following setting can be performed.

- Character color

<<Screen>>

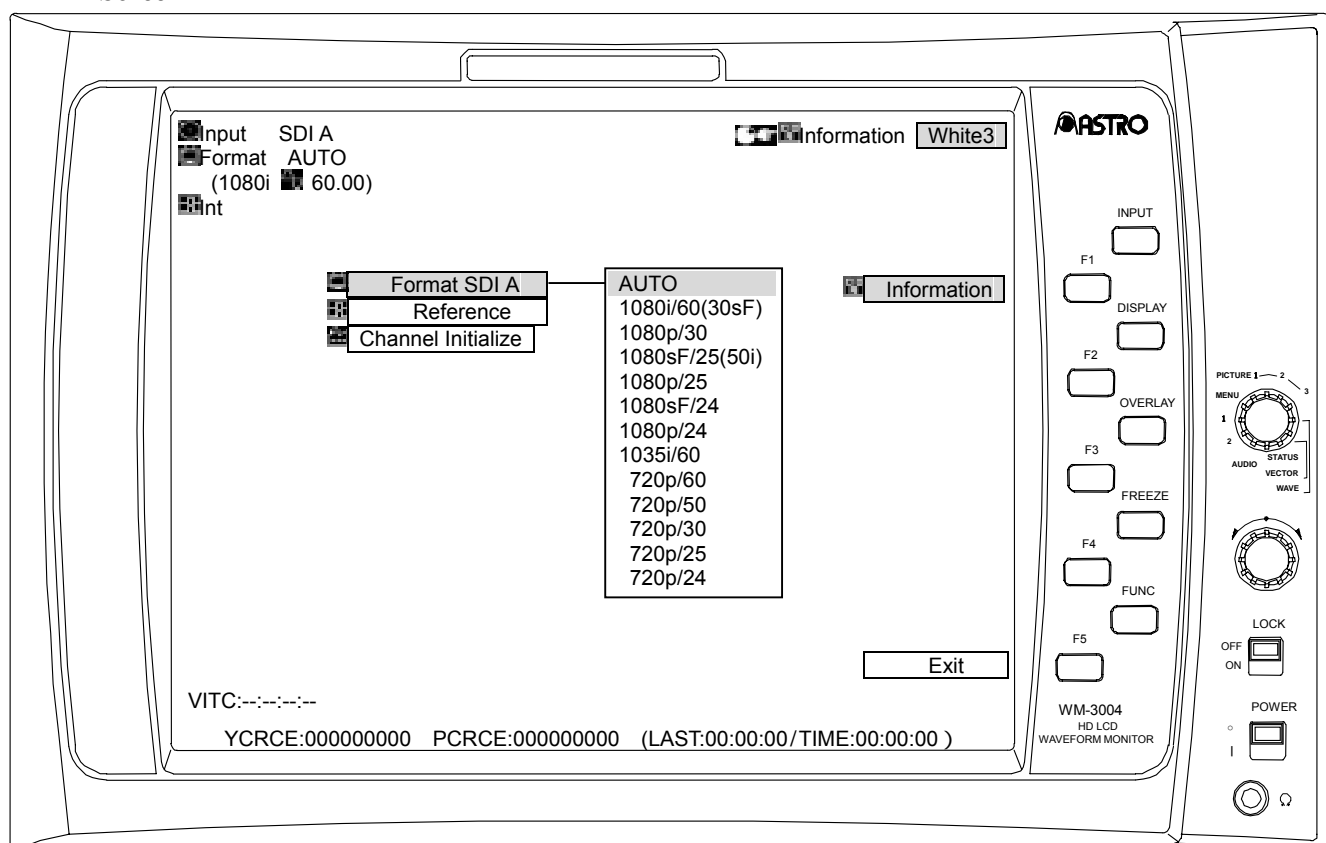

[Description of operations]

Switch	Description of function
FUNC switch	Press this to return the display to the normal screen. (Refer to section 3.3.8.1)
F1 switch Information	Press this to select the color (any of 63 colors) of the characters using the adjustment dial. When the setting switch is pressed, the character color is restored to the initial value.
F2 switch	(Not used)
F3 switch	(Not used)
F4 switch	(Not used)
F5 switch Exit	Press this to return the display to the normal screen. (Refer to section 3.3.8.1)
OVERLAY switch	When this is held down, the display is returned to the normal screen. (Refer to section 3.3.8.1)

3.3.9 HELP mode

<<Functions>>

The hierarchical levels of the modes and operation methods are displayed together.

[Description of operations]

Switch	Description of function
FUNC switch	(Not used)
Adjustment dial	Used to scroll the pages.
Setting switch	(Not used)
F1 switch	(Not used)
F2 switch	(Not used)
F3 switch	(Not used)
F4 switch	(Not used)
F5 switch	(Not used)

3.4 Installing and securing the monitor

Provided at the top and bottom of the monitor are 1/4-20UNC threaded holes. Fit screws into these holes to anchor the monitor to a tripod, arm, etc.

Do not attach any items to the WM-3004 other than the optional accessories (see Note), battery and cable. Otherwise, the threaded holes may be damaged.

To mount the monitor in a rack, use the fixtures available as optional accessories.

Note: See Chapter 5.

CHAPTER 4 MAIN SPECIFICATIONS

4.1 Input formats

Format		Frame Rate (Hz)	Active Line per Frame	Total Line Per Frame	Line Frequency (kHz)	Samples per Active Line	Samples per Total Line	Scanning *1	*2
1035i/60	1035i/59.94	30/1.001	1035	1125	33.72	1920	2200	i	<1>
	1035i/60	30	1035	1125	33.75	1920	2200	i	
1080i/60	1080i/59.94 1080sF/29.97	30/1.001	1080	1125	33.72	1920	2200	i sF	<1> <2>
	1080i/60 1080sF/30	30	1080	1125	33.75	1920	2200	i sF	<1> <2>
1080p/30	1080p/29.97	30/1.001	1080	1125	33.72	1920	2200	p	<2>
	1080p/30	30	1080	1125	33.75	1920	2200	p	
1080sF/25 (1080i/50)	1080sF/25 1080i/50	25	1080	1125	28.13	1920	2640	sF i	<2>
1080p/25	1080p/25	25	1080	1125	28.13	1920	2640	p	<2>
1080sF/24	1080sF/23.98	24/1.001	1080	1125	26.97	1920	2750	sF	<2>
	1080sF/24	24	1080	1125	27.00	1920	2750	sF	
1080p/24	1080p/23.98	24/1.001	1080	1125	26.97	1920	2750	p	<2>
	1080p/24	24	1080	1125	27.00	1920	2750	p	
720p/60	720p/59.94	60/1.001	720	750	44.96	1280	1650	p	<3>
	720p/60	60	720	750	45.00	1280	1650	p	
720p/50	720p/50	50	720	750	36.00	1280	1980	p	<3>
720p/30	720p/29.97	30/1.001	720	750	22.48	1280	3300	p	<3>
	720p/30	30	720	750	22.50	1280	3300	p	
720p/25	720p/25	25	720	750	18.75	1280	3960	p	<3>
720p/24	720p/23.98	24/1.001	720	750	17.98	1280	4125	p	<3>
	720p/24	24	720	750	18.00	1280	4125	p	

*1: Scanning abbreviations

i = Interlace

sF = Segmented Frame

p = Progressive

*2: Standards

<1> BTA S-001B, S-002B, S-004B complied with

<2> SMPTE 274M complied with

<3> SMPTE 296M complied with

4.2 Input signal systems

SDI input specification	Specification	
SDI input	HDTV	BTA S-004B and SMPTE 292M standards complied with, NRZI SDI signal
	Field (frame) frequency, 60.00/59.94 [Hz], etc. automatically scanned Automatic scanning of input format enabled	

Analog input specification	Specification	
HDTV YPbPr input	BTA S-001B, SMPTE 274M and SMPTE 296M standards complied with	
	Field frequency, 60.00/59.94 [Hz], etc. automatically scanned Automatic scanning of input format enabled	
	Y on Sync used for synchronization	

4.3 Display system

Display system	Specification
Liquid crystal	a-Si TFT LCD
Screen size	6.4 inch
Resolution	1024(H) × 768(V)Pixels
Image area	HD-TV : 960(H)×540(V) Pixels
Pixel pitch	0.126(W)×0.126(H) mm

4.4 Headphones output

Maximum output	10mW(32Ω/1kHz)
Frequency response	500Hz to 5kHz(0dB to 3dB)

4.5 Concerning the adjustment values

- **Brightness** The offset level of the luminance signal can be varied in the range from -50.00 to +50.00%.

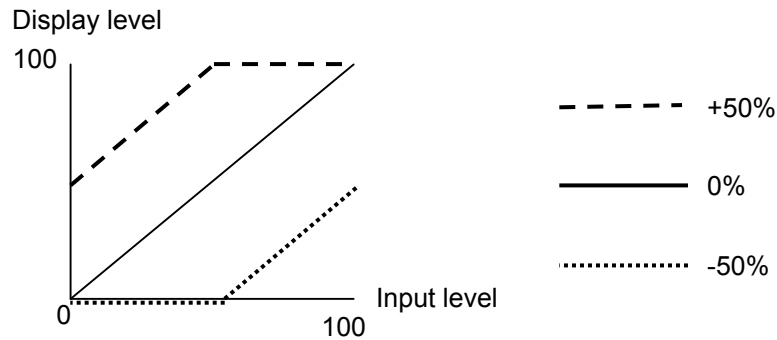

- **Y gamma** The Y gamma can be corrected in the range from 0.500-2.000; when 2.000 is exceeded, "Effect" results.

Y gamma correction

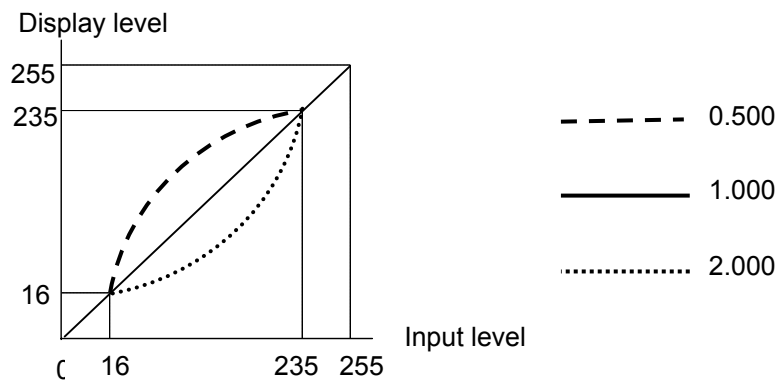

With "Effect" (shading accentuated)

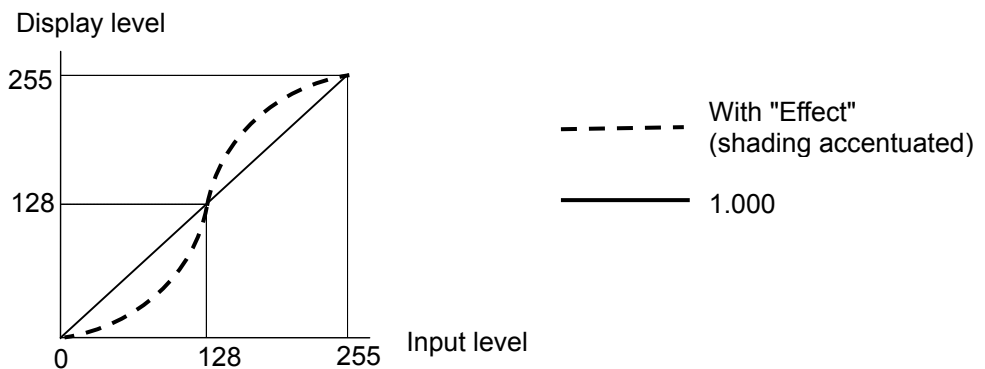

- Contrast The level of the luminance signal can be varied in the range from 0.0-200.0%.

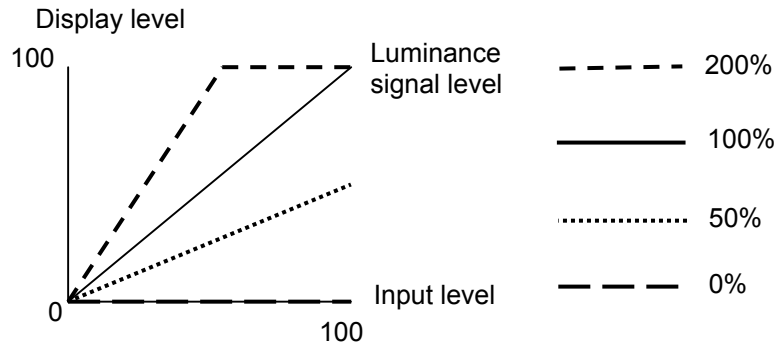

- Chroma, Pb (Cb), Pr (Cr) The level of the chrominance signals can be varied in the range from 0.0-200.0%.

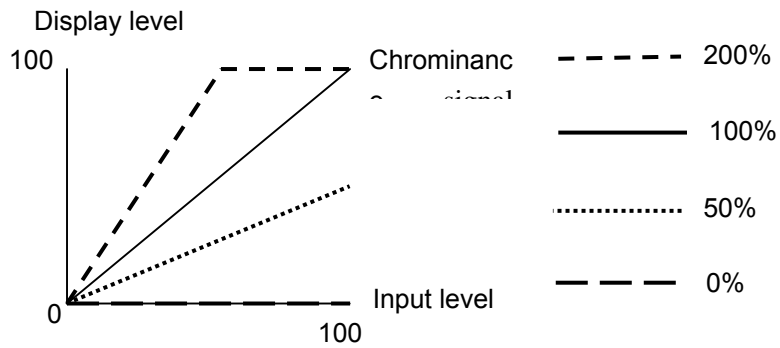

4.6 Settings at initialization

The settings established when the WM-3004 was shipped from the factory or when they have been initialized are listed below.

4.6.1 Common setting items

The settings for the following items are the same whether for the SDI A, SDI B or analog channels.

Setting item	Setting
Input	SDI A
Display	ON
Overlay	OFF
Half Turn	OFF
Freeze	OFF
Marker	OFF (selected marker: frame, center)
Parade/Overlay	Parade
Y	ON
Pb(Cb)	ON
Pr(Cr)	ON
LineSelect	OFF
SWEEP	1H
GAIN	×1
MAG	×1
H cursor	OFF
V cursor	OFF
MOVE	BASE
Waveform	YPbPr
V anc(Wave)	OFF
H Blank	OFF
Scale	%
LPF(Wave)	ON
Vectorscope	Fix ×1
V anc(Vect)	OFF
Scale	100%
LPF(Vect)	ON
Cardinal numbers	HEX
Animation	ON

4.6.2 Setting items by channel

The following items are set separately for the SDI A, SDI B and analog channels.

Setting item	Setting
Bright	0.00%
Contrast	100.0%
Chroma	100.0%
Pb(Cb)	100.0%
Pr(Cr)	100.0%
Y Gamma	1.000
Filter	ON
Mono	OFF
FRC	OFF
Green	ON
Blue	ON
Red	ON
Volume	128
Output	L:1CH, R:2CH
Information Color	White3
Marker Color	White3
Scale Color	White1
Waveform Color	Color15
Cursor Color	Yellow2
Vector Color	Green16
Status Color	White3

4.7 General specifications

WM-3004 operating environment and ratings

Operating temperature	0 to 40°C
Operating humidity	(no condensation must be allowed to form)
Rated voltage	10-18V DC
Power consumption	24W (when HD-SDI signals are input)
Service life	35,000 hours (LCD backlight)
Dimensions	210(W) × 133(H) × 83(D) mm (excluding protrusions) 210(W) × 133(H) × 105(D) mm (including protrusions)
Weight	Approx. 1.5 kg

4.8 Outline drawings

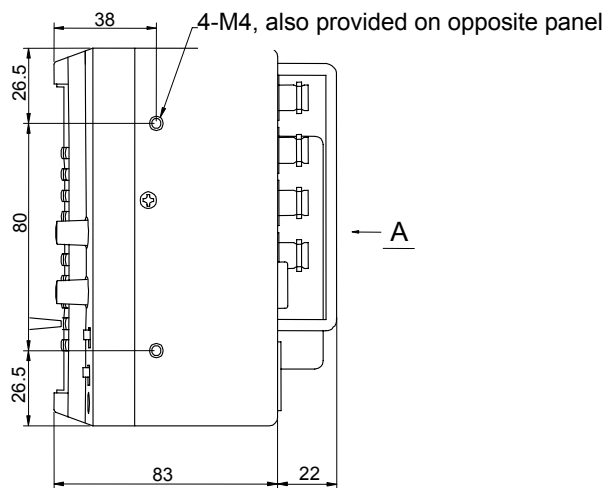
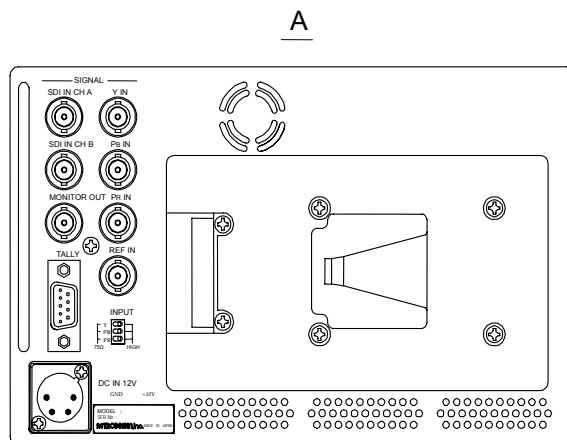
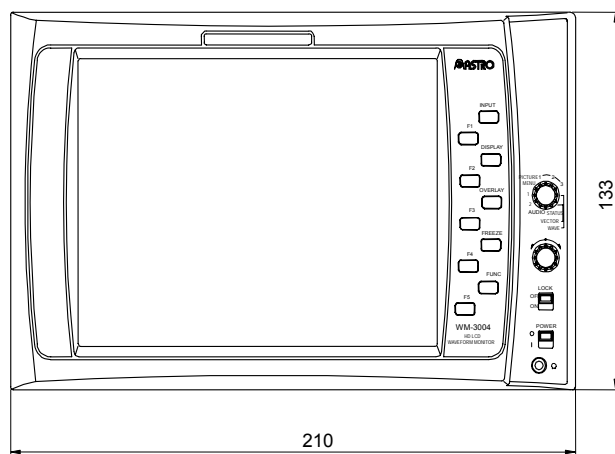
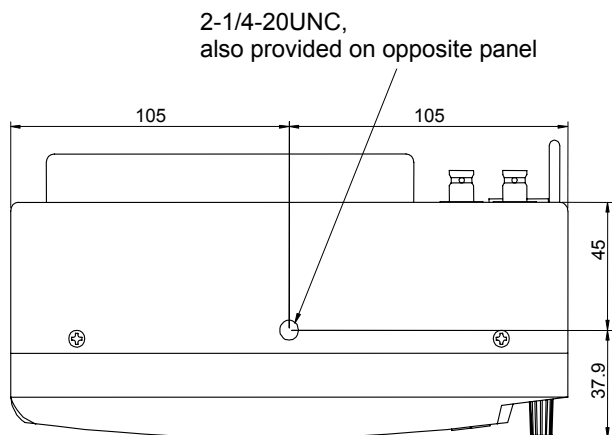

CHAPTER 5 STANDARD AND OPTIONAL ACCESSORIES

5.1 Standard accessories

WM-3004 instruction manual	1 copy
Rubber leg	4 pcs
M4 screws (for attaching rack-mounting fixtures)	4 pcs
AC/DC adapter	1 pc (*1)

5.2 Optional accessories

Provided for the WM-3004 as the optional accessories of the LCD unit (main unit) are rack-mounting fixtures, etc.

Additional optional accessories are released from time to time: contact an Astro sales representative for the latest information.

For details on the type of monitor in which the battery adapter for an Anton Bauer battery can be installed, contact an Astro sales representative.

Product	Model name
AC/DC adapter	DM-3005A - 03 (*1)
Single rack-mounting fixtures	DM-3005 - 04
Double rack-mounting fixtures	DM-3005 - 05

*1: The AC/DC adapter listed among the optional accessories is equivalent to the one listed in the standard accessories.

NOTICE

- An incorrectly collated manual or a manual with missing pages will be replaced.
- All copyrights pertaining to this manual are the property of Astrodesign.
- This manual may not be used or copied in whole or in part without permission.
- The contents of this manual are subject to change without prior notice due to improvements.
- The manufacturer will not be liable for any outcome which results from the operation of the product.
- The products and product names mentioned in this manual are the trademarks and registered trademarks of the companies concerned.
- All inquiries concerning this product should be addressed to your dealer or to the manufacturer at the contact numbers given below.

ASTRODESIGN, INC.

Head Sales Division 2-6-17 Haramachi, Meguro-ku, Tokyo, Japan 152-0011
Tel: <03> 5720-5300, Fax: <03> 5720-6353

Osaka Sales Office 1-18-27-1010 Higashi-Nakajima, Higashi-Yodogawa-ku, Osaka,
Japan 533-0033
Tel: <06> 6328-8558, Fax: <06> 6328-5058

